

A-A

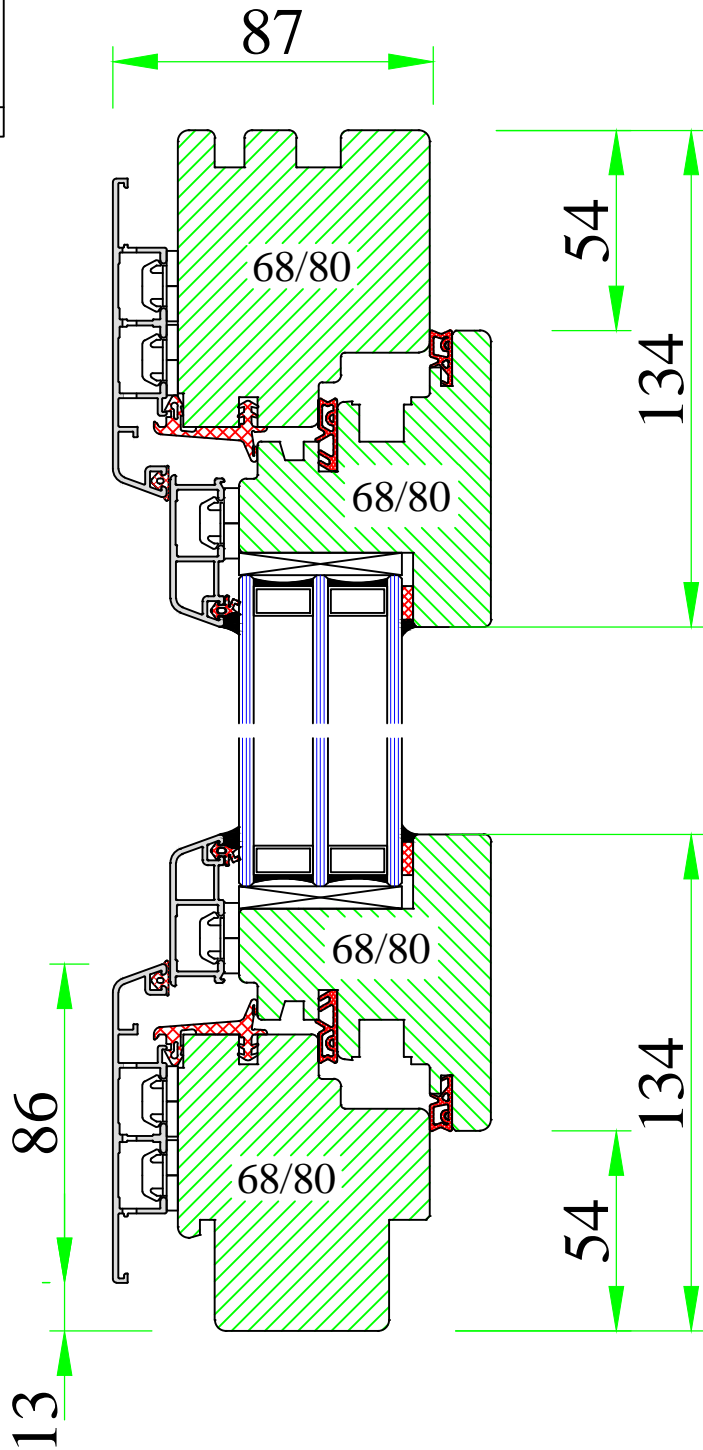

UNI WINDOWS Ltd.
 Unit 6, Edgefield Industrial Est.
 Loanhead, EH20 9TB
 Tel.: 0131 448 3931

MARCONI MAX
 Inward opening tilt and turn window

Version: 1	Scale: 1:2
Date: 15.05.14	Drawing: NOE/1

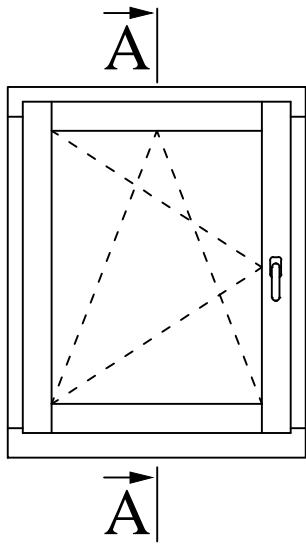

A-A

87

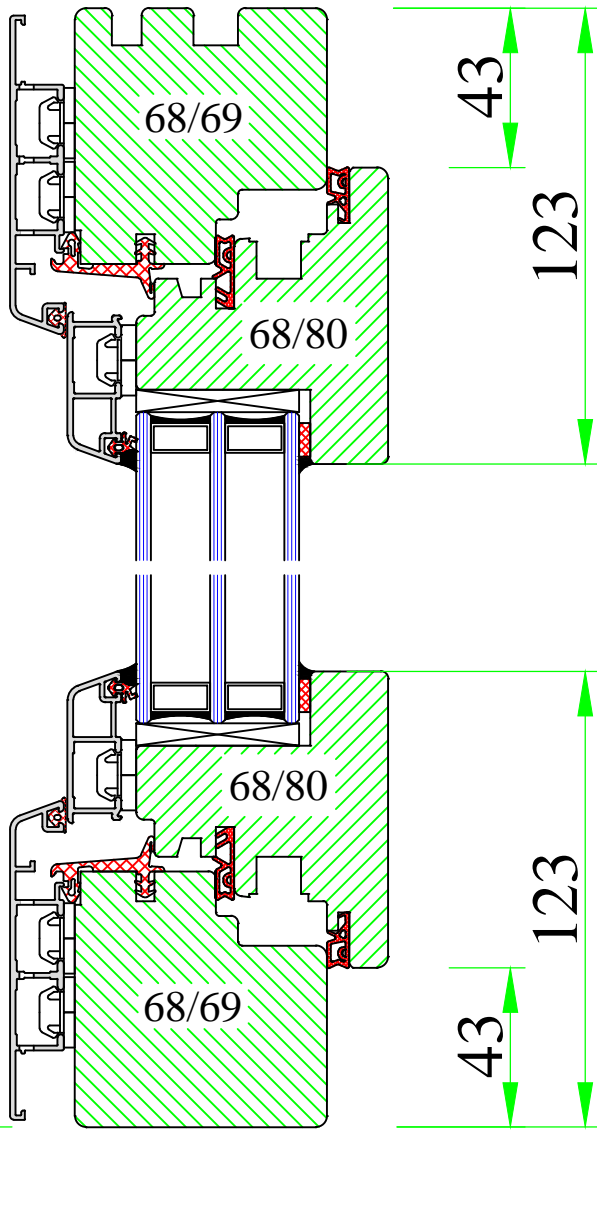

UNI WINDOWS Ltd.
 Unit 6, Edgefield Industrial Est.
 Loanhead, EH20 9TB
 Tel.: 0131 448 3931

MARCONI MAX 2
 Inward opening tilt and turn window

Version: 1	Scale: 1:2
Date: 15.05.14	Drawing: NOE2-1

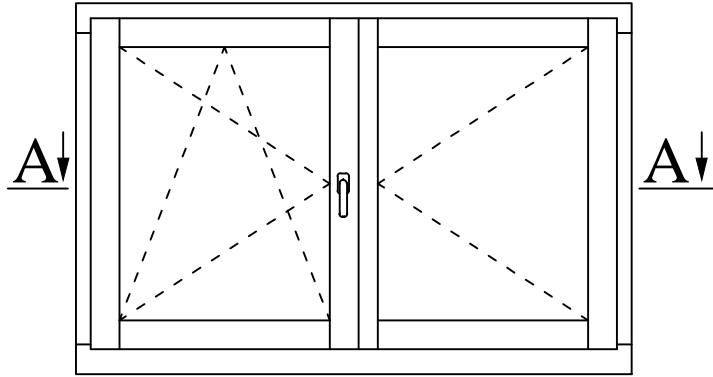

A-A

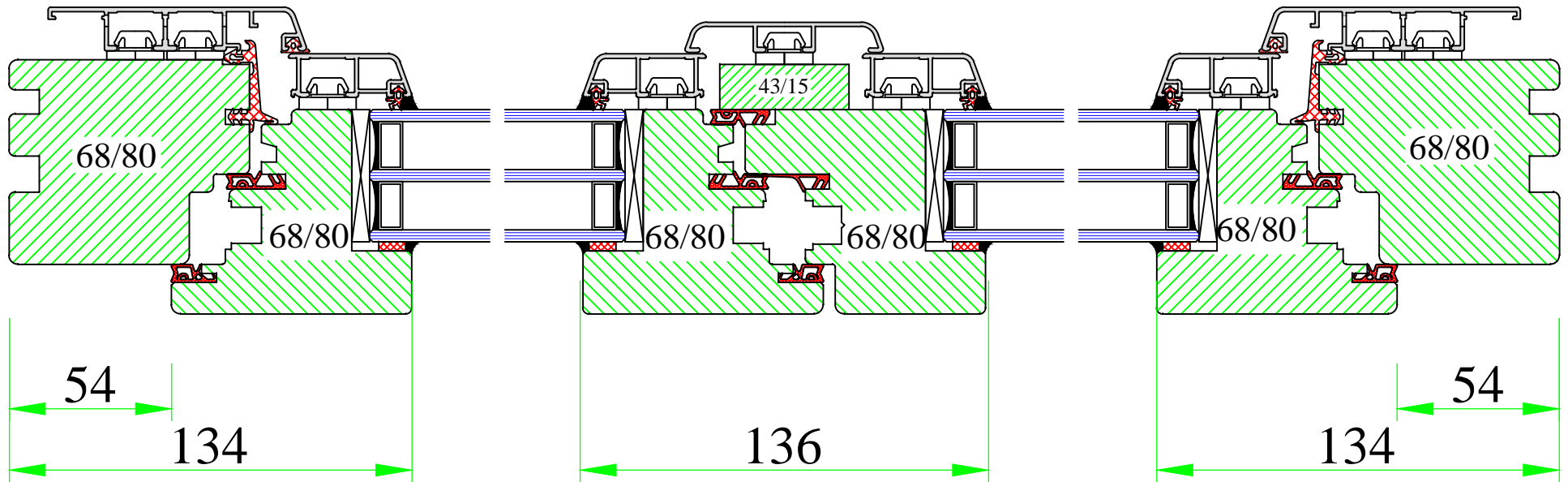

UNI WINDOWS Ltd.
 Unit 6, Edgefield Industrial Est.
 Loanhead, EH20 9TB
 Tel.: 0131 448 3931

MARCONI MAX
 Double opening window with "flying" mullion

Version: 1	Scale: 1:2
Date: 15.05.14	Drawing: NOE/2

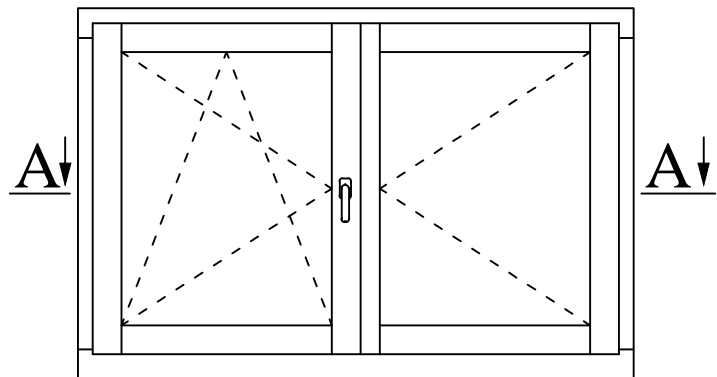

A-A

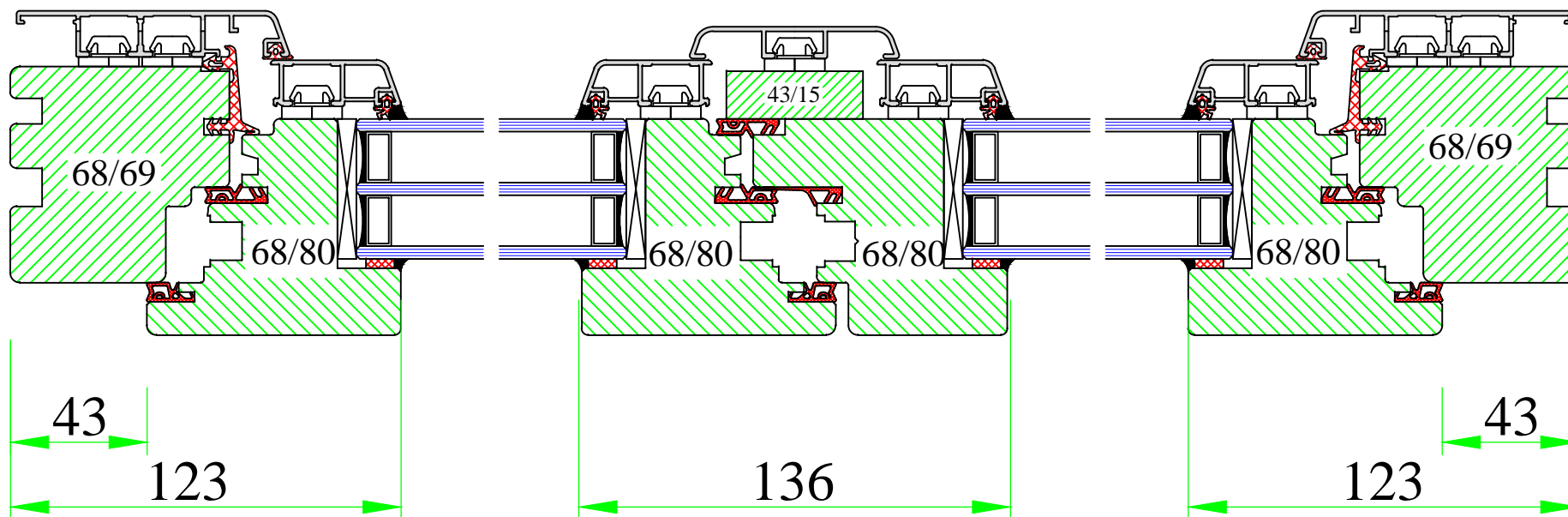

UNI WINDOWS Ltd.
 Unit 6, Edgefield Industrial Est.
 Loanhead, EH20 9TB
 Tel.: 0131 448 3931

MARCONI MAX 2
 Double opening window with "flying" mullion

Version: 1	Scale: 1:2
Date: 15.05.14	Drawing: NOE2/2

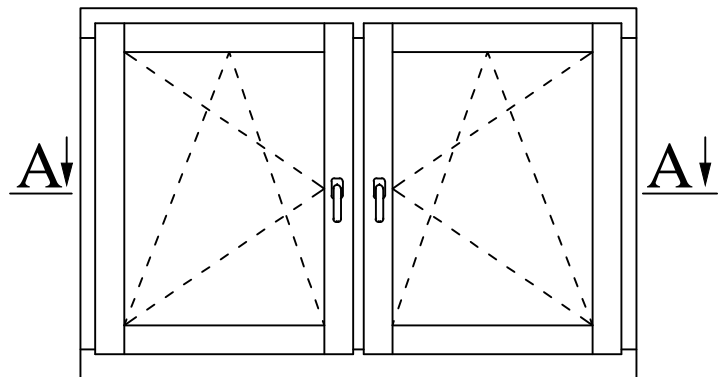

A-A

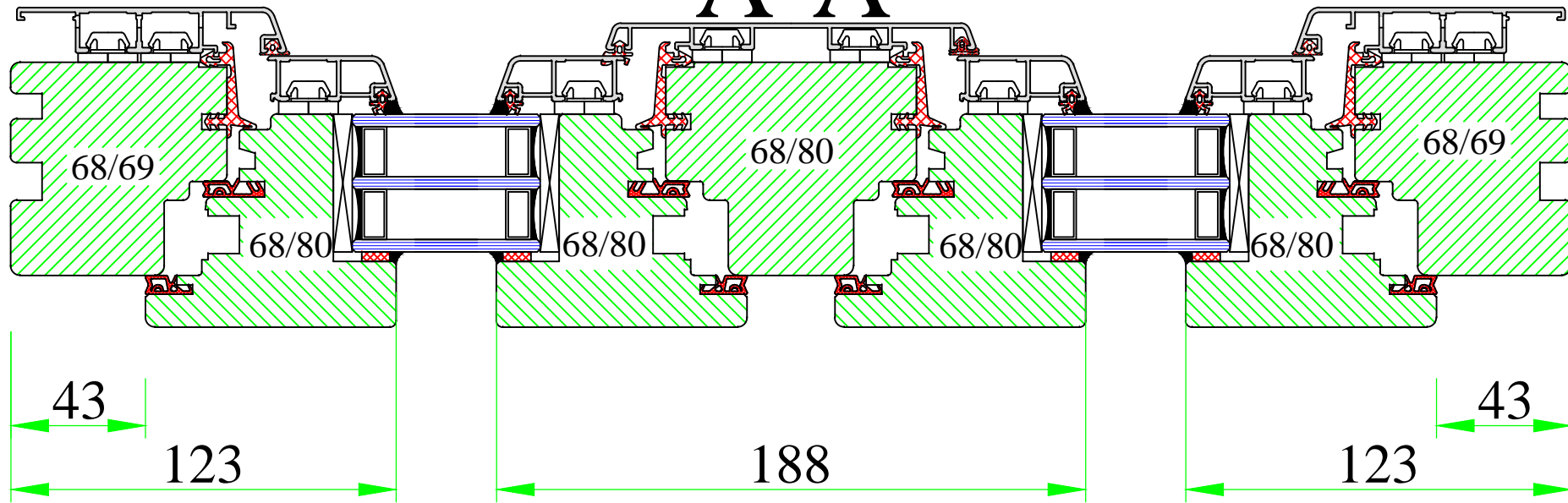

UNI WINDOWS Ltd.
 Unit 6, Edgefield Industrial Est.
 Loanhead, EH20 9TB
 Tel.: 0131 448 3931

MARCONI MAX 2
 Double opening window – fixed mullion 80mm

Version: 1	Scale: 1:2
Date: 15.05.14	Drawing: NOE2/3

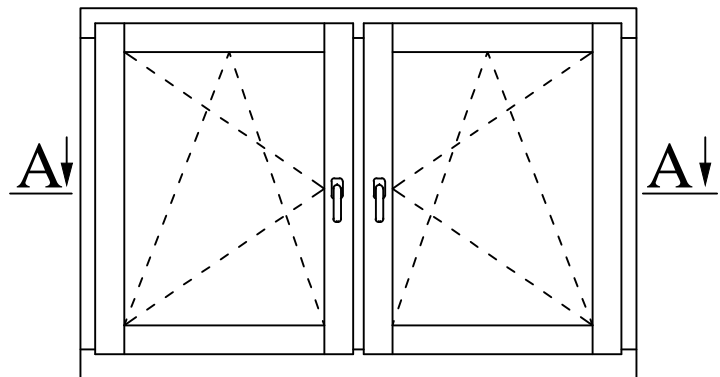

A-A

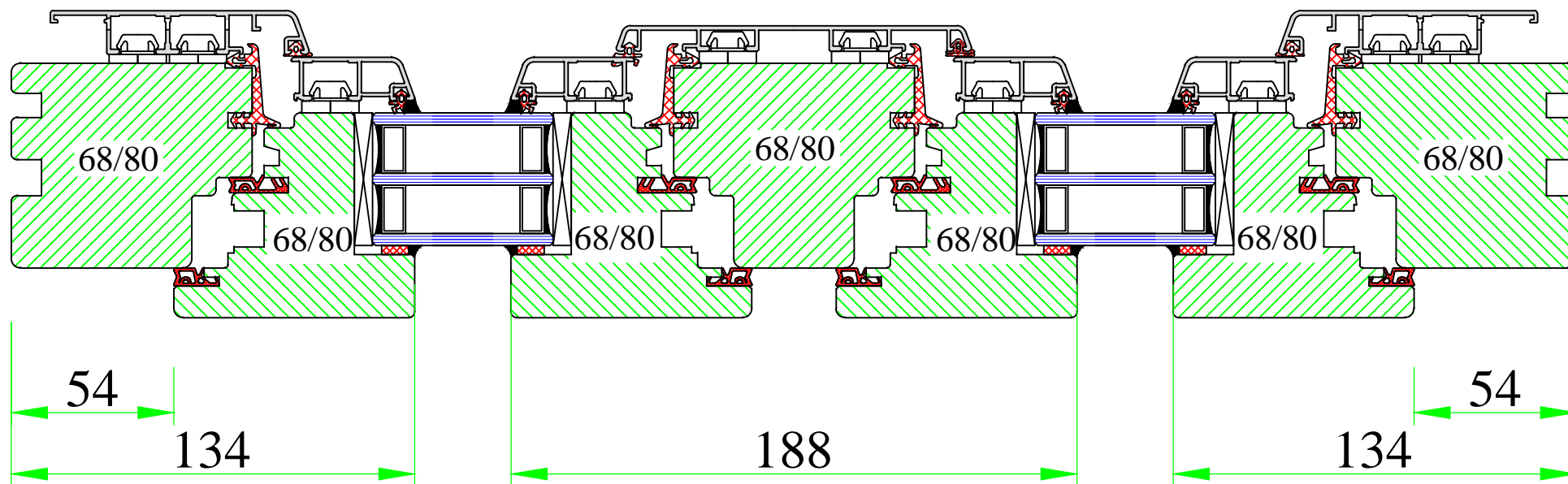

UNI WINDOWS Ltd.
 Unit 6, Edgefield Industrial Est.
 Loanhead, EH20 9TB
 Tel.: 0131 448 3931

MARCONI MAX
 Double opening window – fixed mullion 80mm

Version: 1	Scale: 1:3
Date: 15.05.14	Drawing: NOE/3

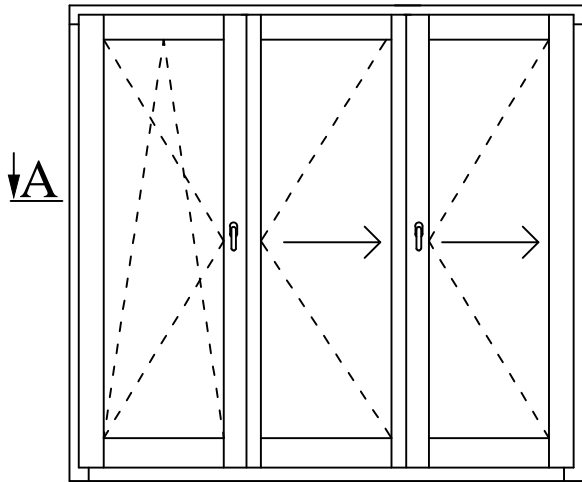

A

A-A

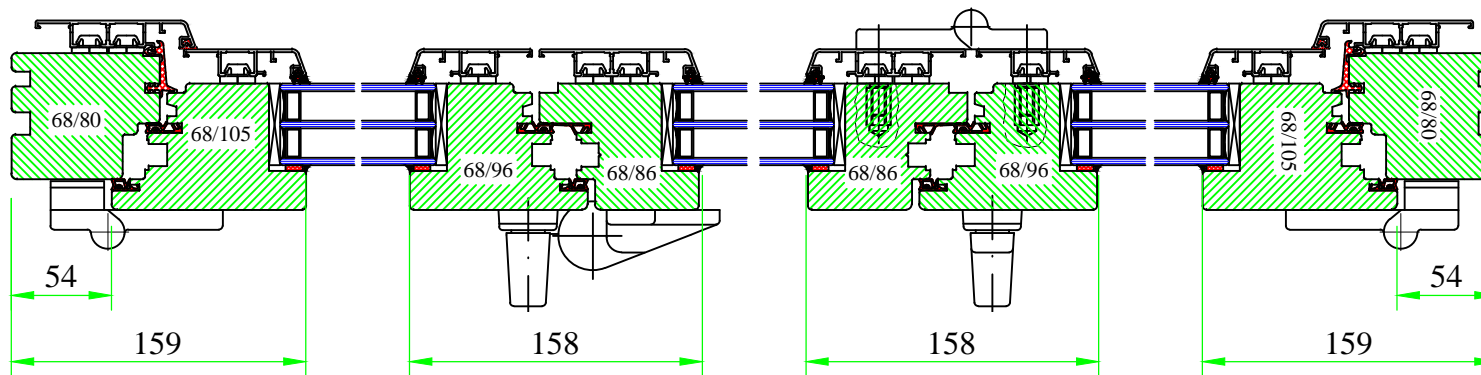

UNI WINDOWS Ltd.
 Unit 6, Edgefield Industrial Est.
 Loanhead, EH20 9TB
 Tel.: 0131 448 3931

Folding sliding doors

MARCONI MAX

Version:
1

Scale:
1:4

Date:
15.05.14

Drawing:
NOE/4

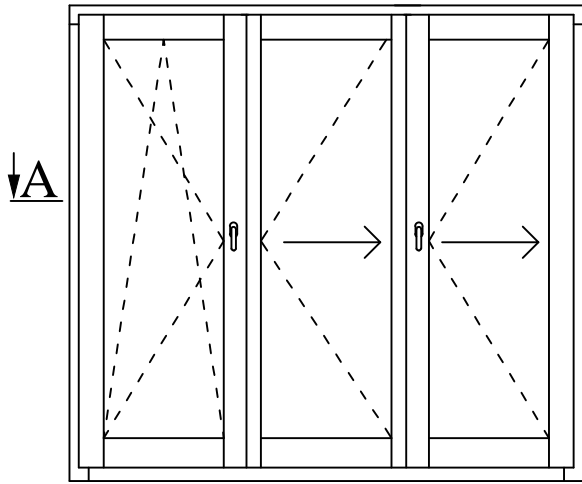

A

A-A

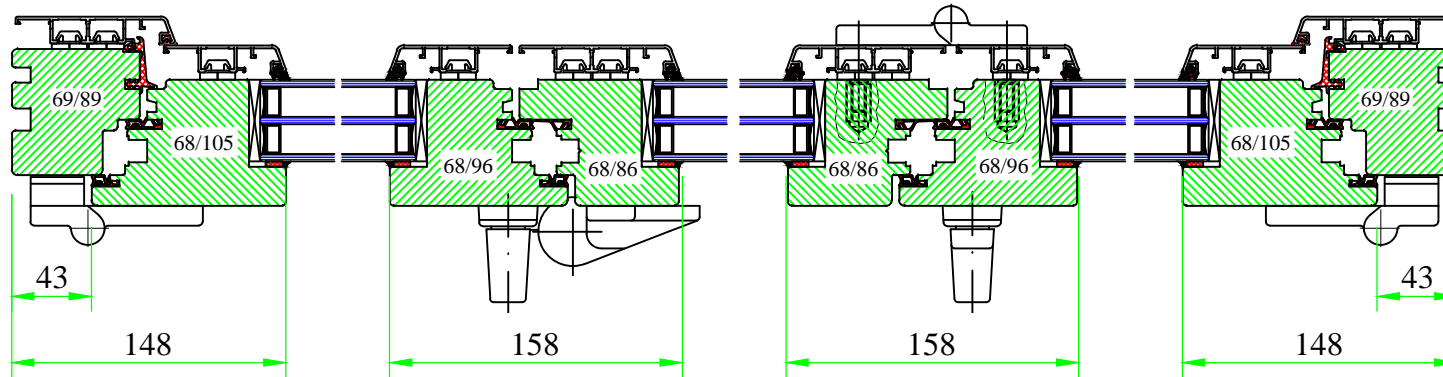

UNI WINDOWS Ltd.
 Unit 6, Edgefield Industrial Est.
 Loanhead, EH20 9TB
 Tel.: 0131 448 3931

MARCONI MAX 2
 Folding sliding doors

Version:
1

Scale:
1:4

Date:
15.05.14

Drawing:
NOE4/2

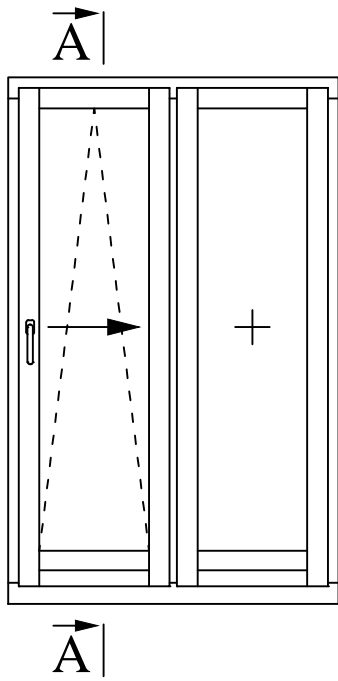

A-A

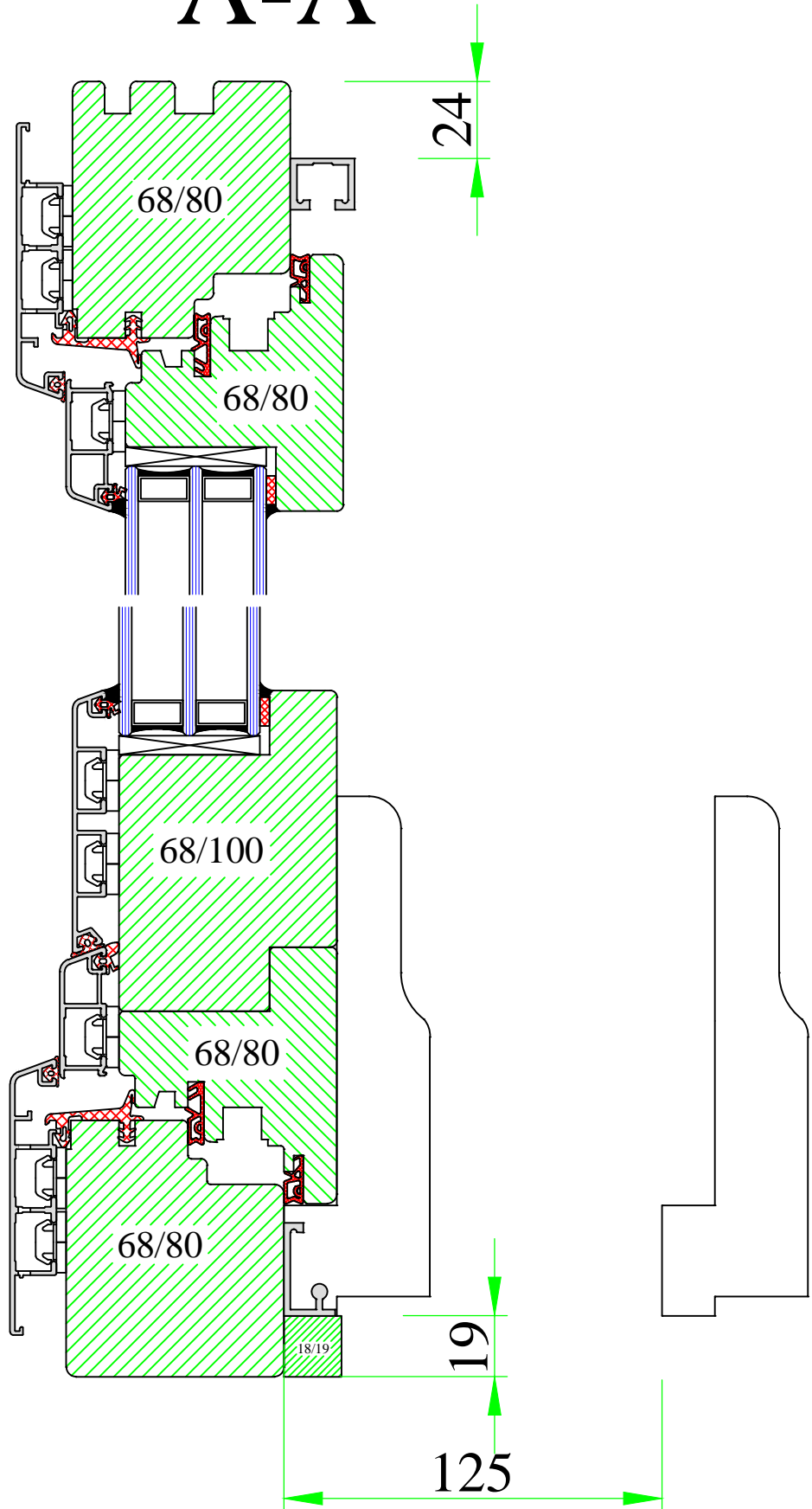

www.uniwin.co.uk



UNI WINDOWS Ltd.
 Unit 6, Edgefield Industrial Est.
 Loanhead, EH20 9TB
 Tel.: 0131 448 3931

Tilt & slide doors

MARCONI MAX

Version:
1

Scale:
1:2

Date:
15.05.14

Drawing:
NOE/8

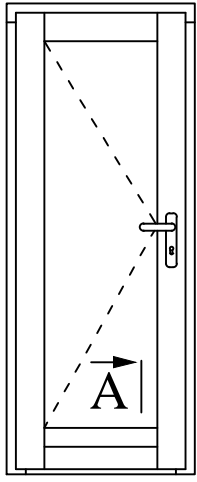

A

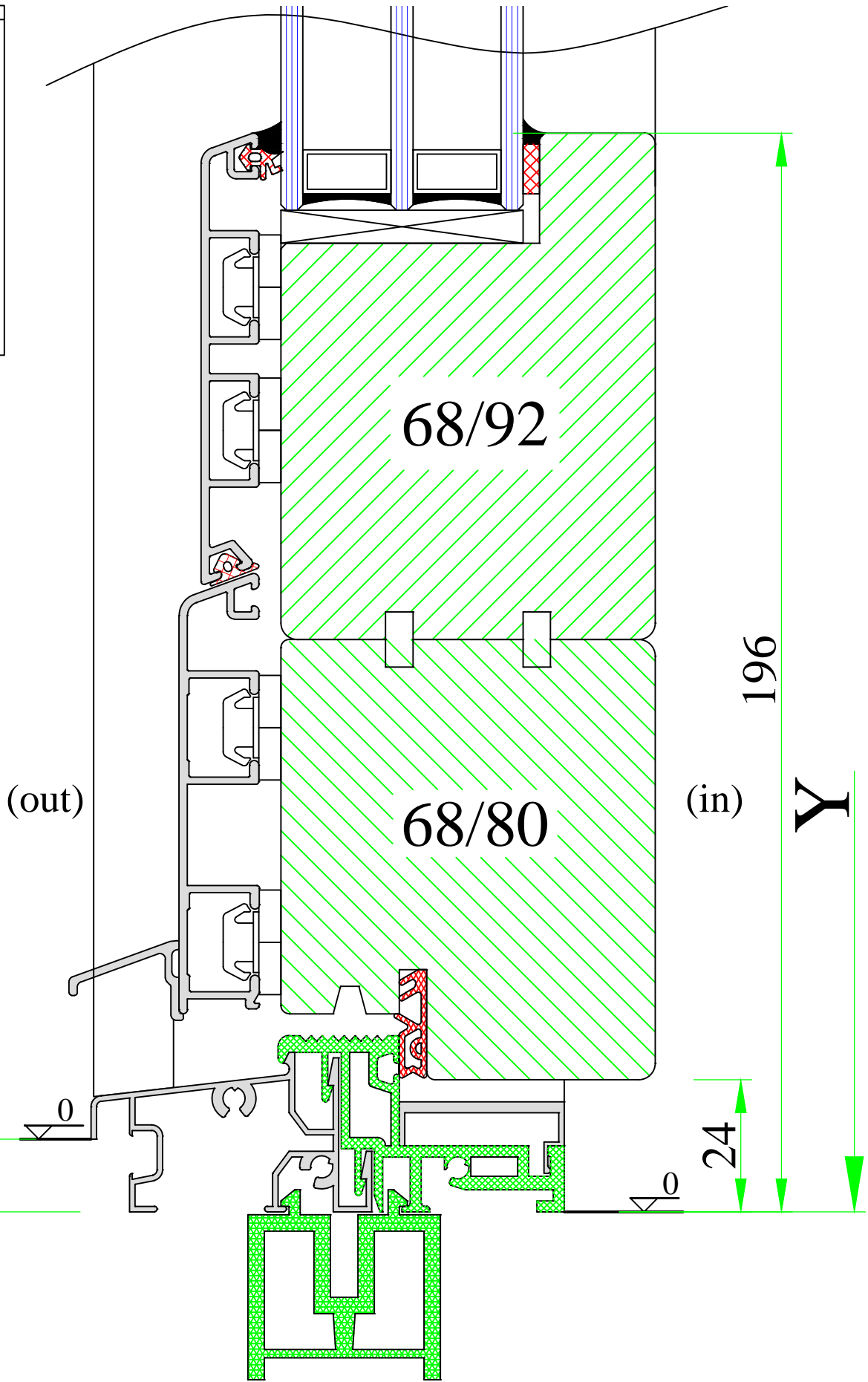

www.uniwin.co.uk



UNI WINDOWS Ltd.
 Unit 6, Edgefield Industrial Est.
 Loanhead, EH20 9TB
 Tel.: 0131 448 3931

MARCONI MAX 1 / 2
 External door with flat treshold Wesser

Version: 1	Scale: 1:1
Date: 15.05.14	Drawing: NED/1

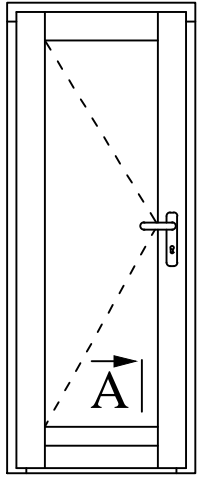

A

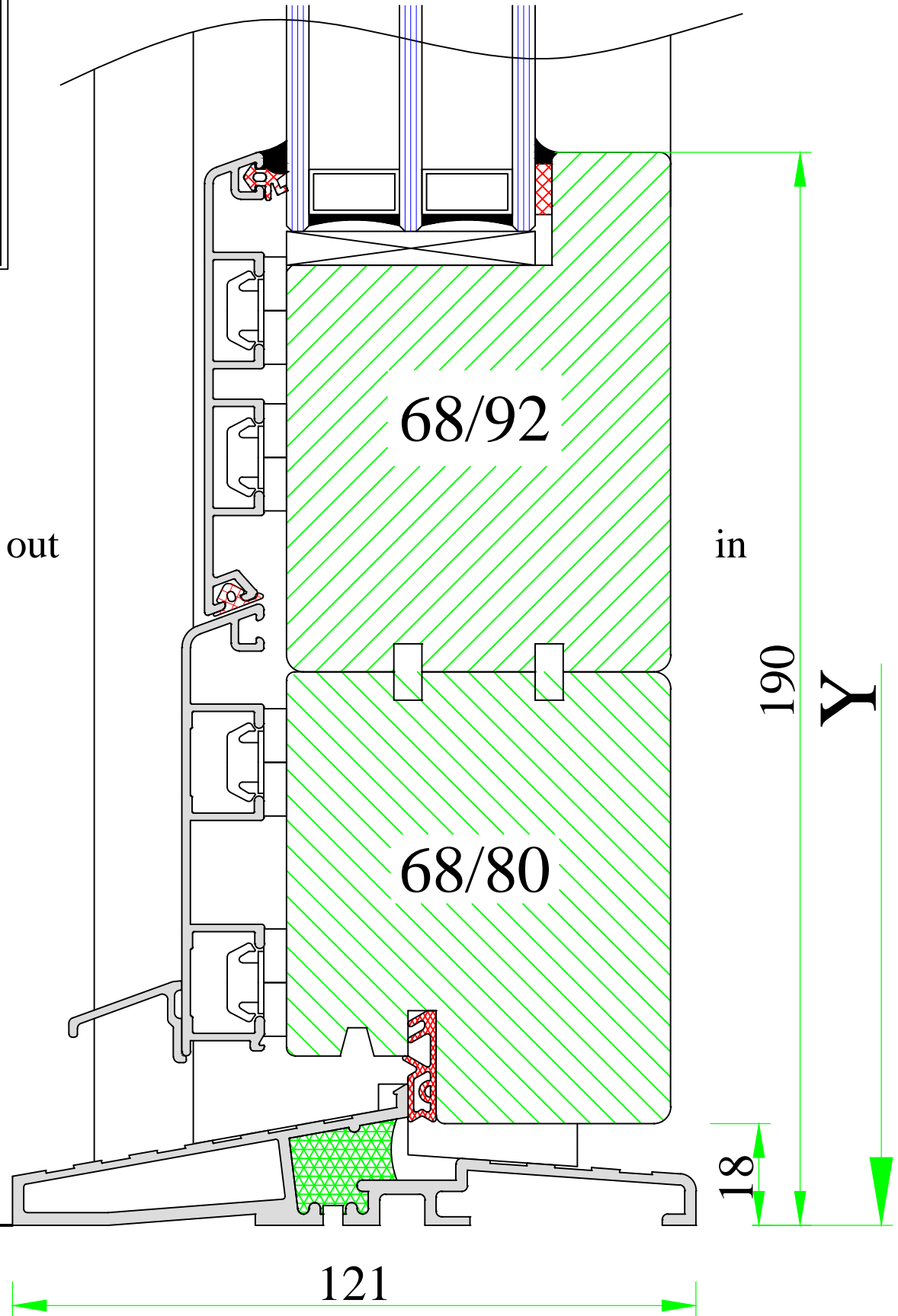

0

out

68/92

in

190

Y

68/80

18

121

www.uniwin.co.uk



UNI WINDOWS Ltd.
 Unit 6, Edgefield Industrial Est.
 Loanhead, EH20 9TB
 Tel.: 0131 448 3931

MARCONI MAX 1 / 2

External door with flat treshold DAFA.

Version:
1

Scale:
1:1

Date:
15.05.14

Drawing:
NED/2

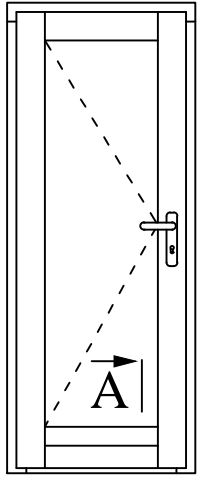

A

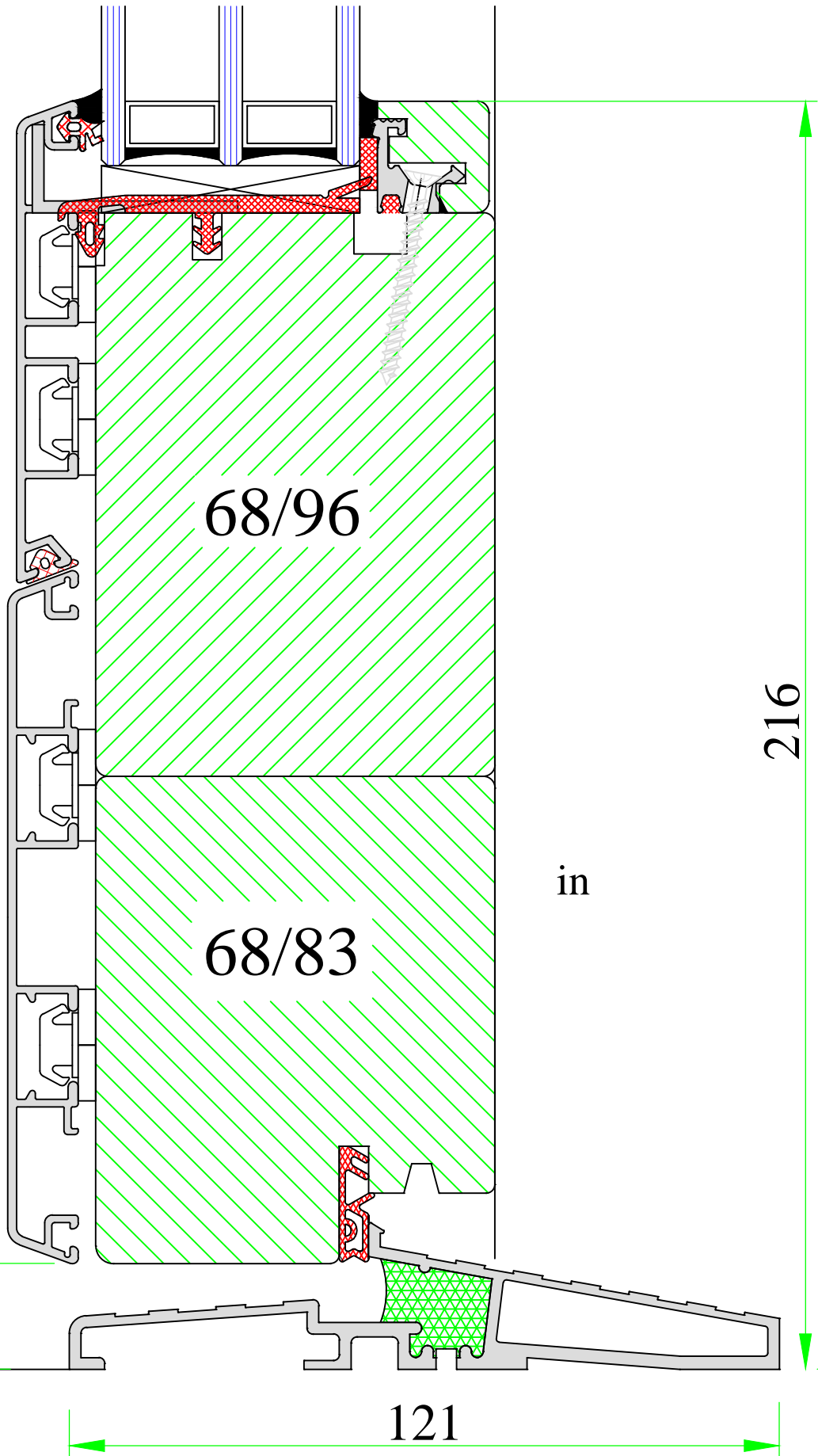

out

68/96

in

68/83

216

Y

18

121

www.uniwin.co.uk



UNI WINDOWS Ltd.
Unit 6, Edgefield Industrial Est.
Loanhead, EH20 9TB
Tel.: 0131 448 3931

MARCONI MAX 1 / 2

External door with threshold DAFA
- outward opening

Version:
1

Date:
15.05.14

Scale:
1:1

Drawing:
NED/3

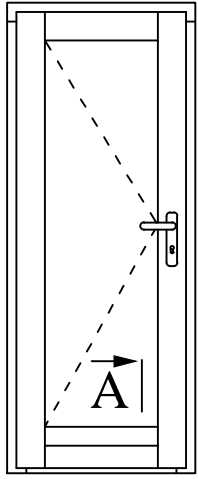

A

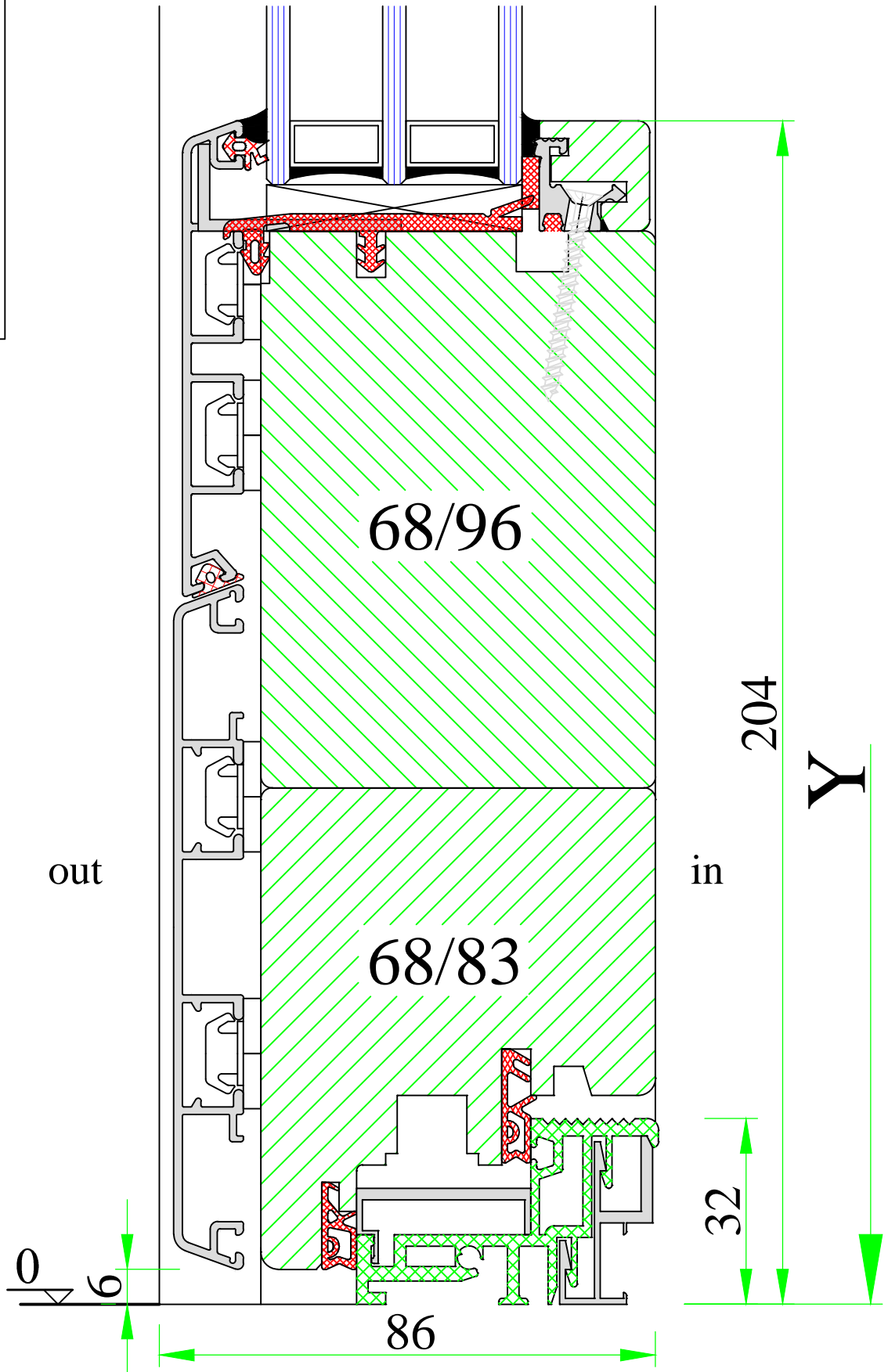

www.uniwin.co.uk



UNI WINDOWS Ltd.
 Unit 6, Edgefield Industrial Est.
 Loanhead, EH20 9TB
 Tel.: 0131 448 3931

MARCONI MAX 1 / 2
 External door with threshold Weser A
 - outward opening

Version: 1	Scale: 1:1
Date: 15.05.14	Drawing: NED/3-1

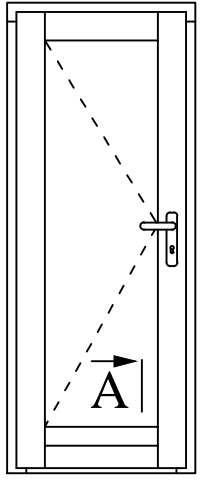

A

out

68/92

in

185

Y

68/80

0

13

85

www.uniwin.co.uk



UNI WINDOWS Ltd.
 Unit 6, Edgefield Industrial Est.
 Loanhead, EH20 9TB
 Tel.: 0131 448 3931

MARCONI MAX 1 / 2

External door with threshold Weser (old)

Version:
1

Scale:
1:1

Date:
15.05.14

Drawing:
NED/4

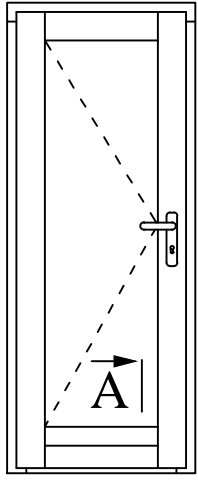

A

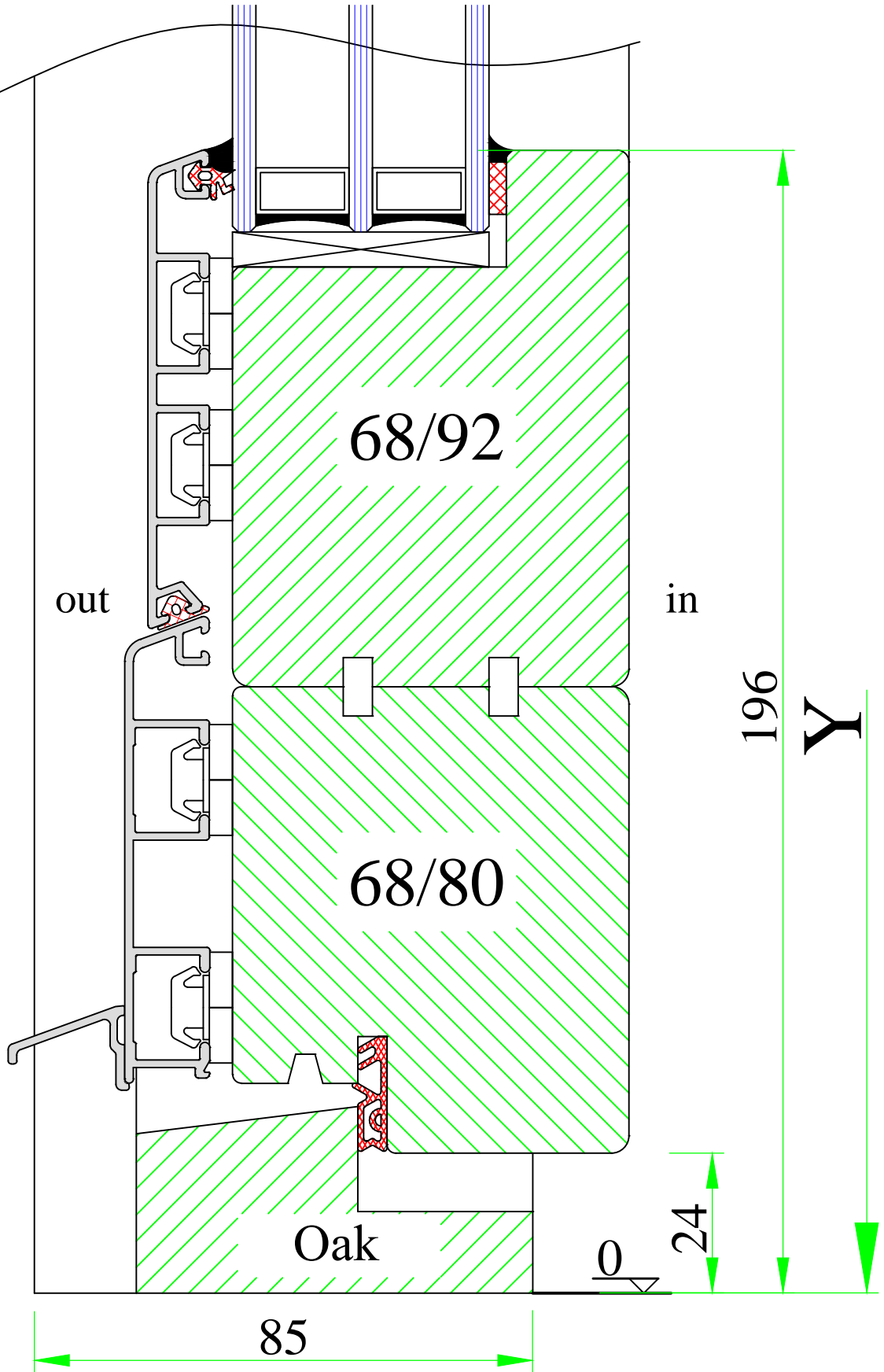

www.uniwin.co.uk



UNI WINDOWS Ltd.
 Unit 6, Edgefield Industrial Est.
 Loanhead, EH20 9TB
 Tel.: 0131 448 3931

MARCONI MAX 1 / 2

Timber threshold for front door – inward opening

Version:
1

Date:
15.05.14

Scale:
1:1

Drawing:
NED/5

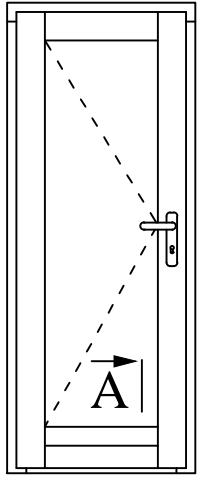

A

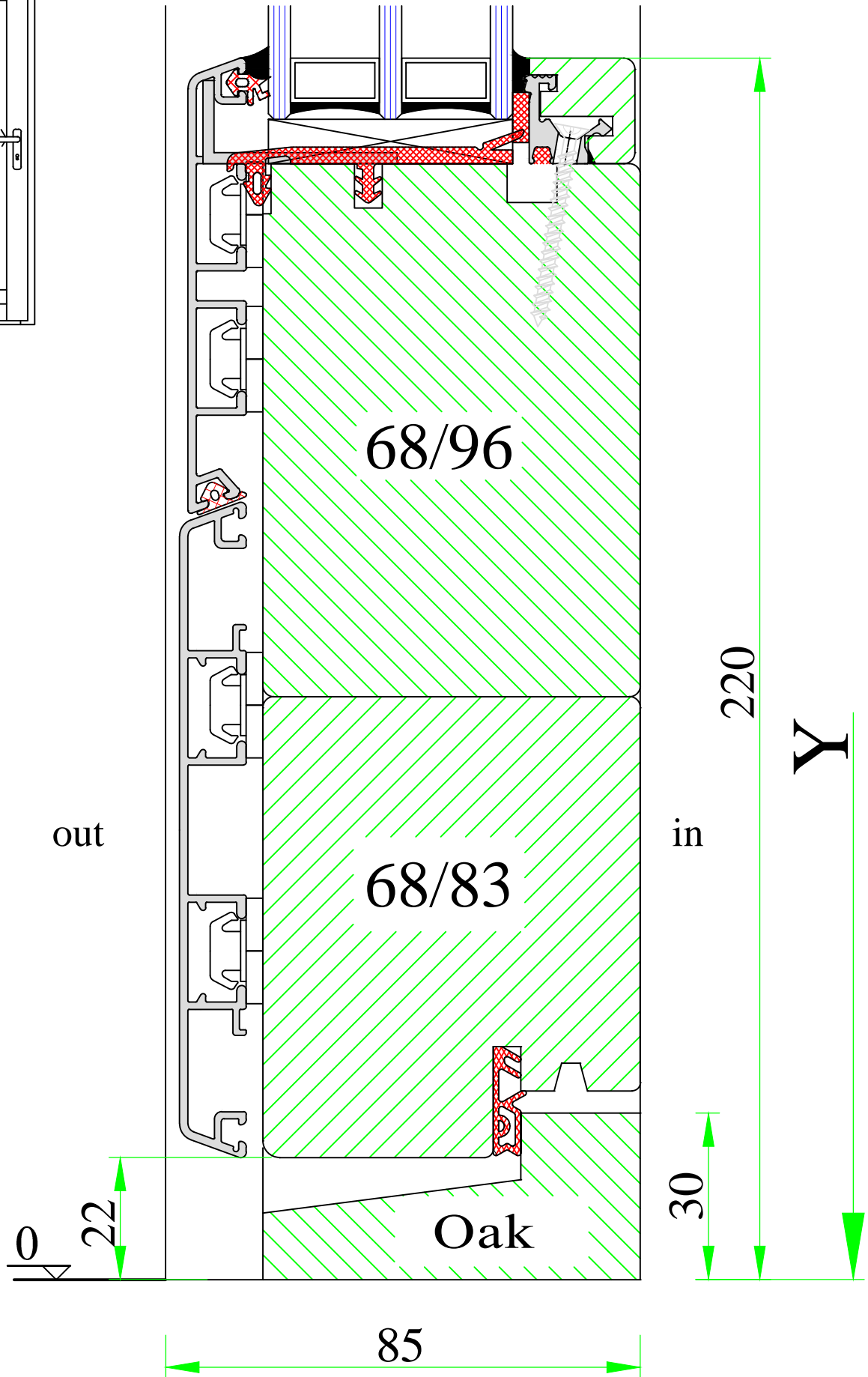

UNI WINDOWS Ltd.
 Unit 6, Edgefield Industrial Est.
 Loanhead, EH20 9TB
 Tel.: 0131 448 3931

MARCONI MAX 1 / 2
 Timber threshold for front door – outward
 opening

Version:
 1
 Date:
 15.05.14

Scale:
 1:1
 Drawing:
 NED/6

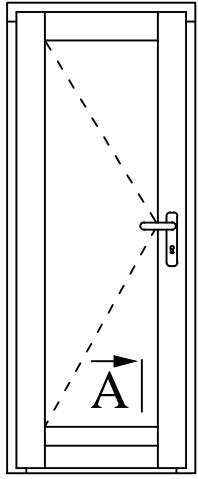

A

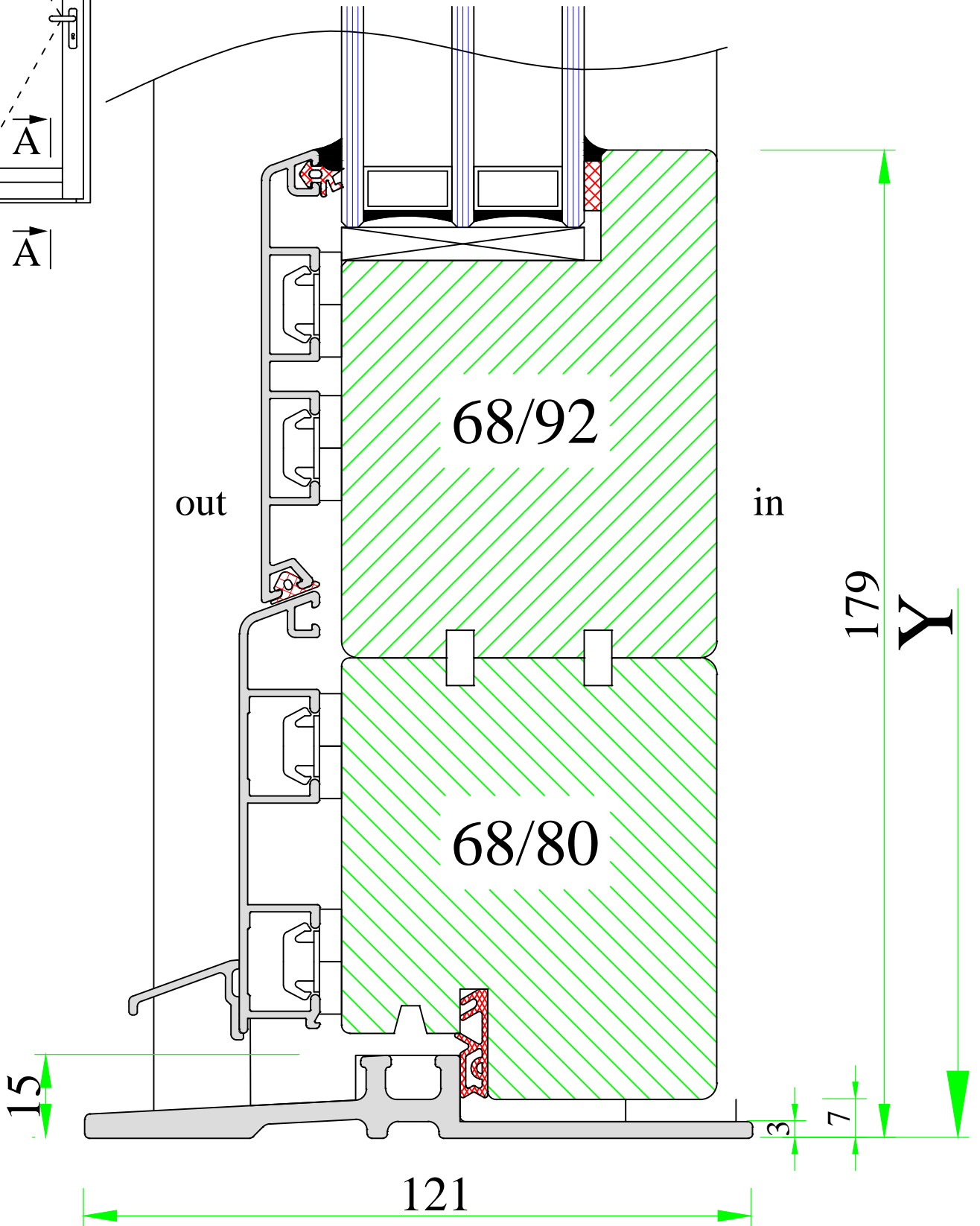

www.uniwin.co.uk



UNI WINDOWS Ltd.
 Unit 6, Edgefield Industrial Est.
 Loanhead, EH20 9TB
 Tel.: 0131 448 3931

MARCONI MAX 1 / 2
 External door with ULT threshold

Version:
1
 Date:
15.05.14

Scale:
1:1
 Drawing:
NED/7

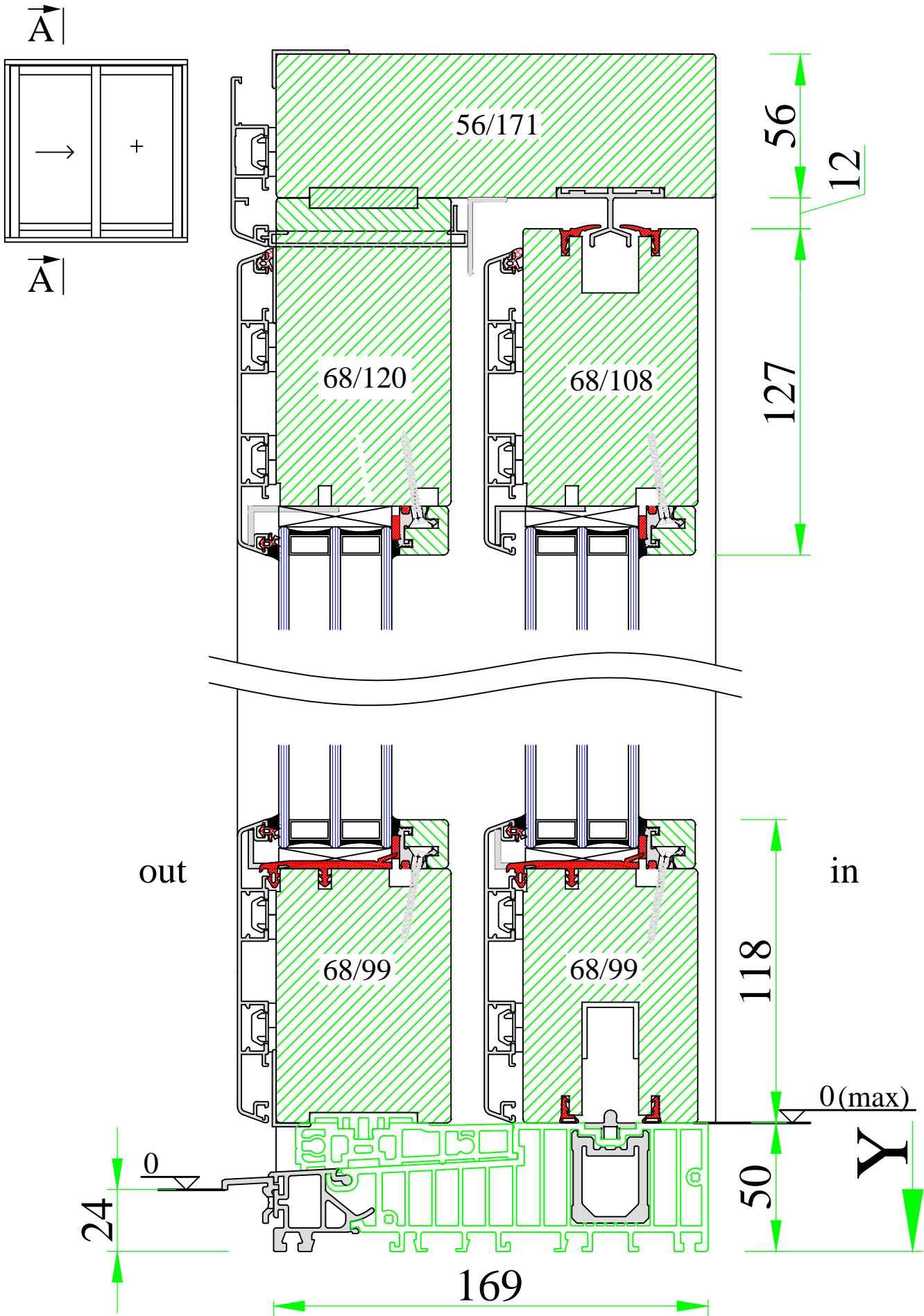

www.uniwin.co.uk



UNI WINDOWS Ltd.
 Unit 6, Edgefield Industrial Est.
 Loanhead, EH20 9TB
 Tel.: 0131 448 3931

MARCONI MAX 1 / 2
 Lift and slide patio door – vertical cut

Version: 1	Scale: 1:2
Date: 15.05.14	Drawing: NEHS/1

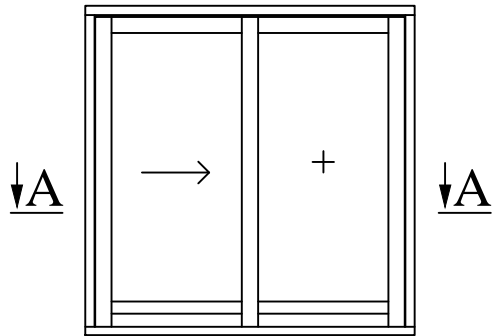

A-A

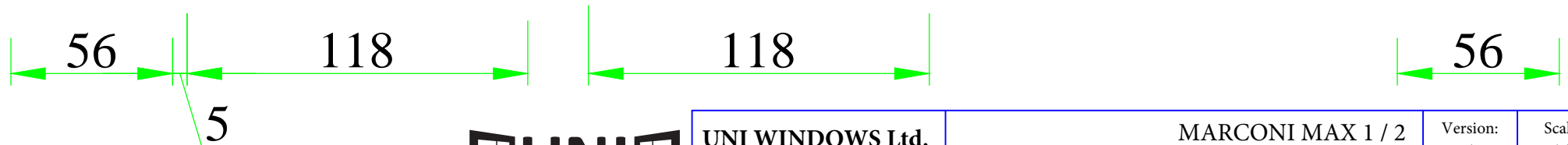
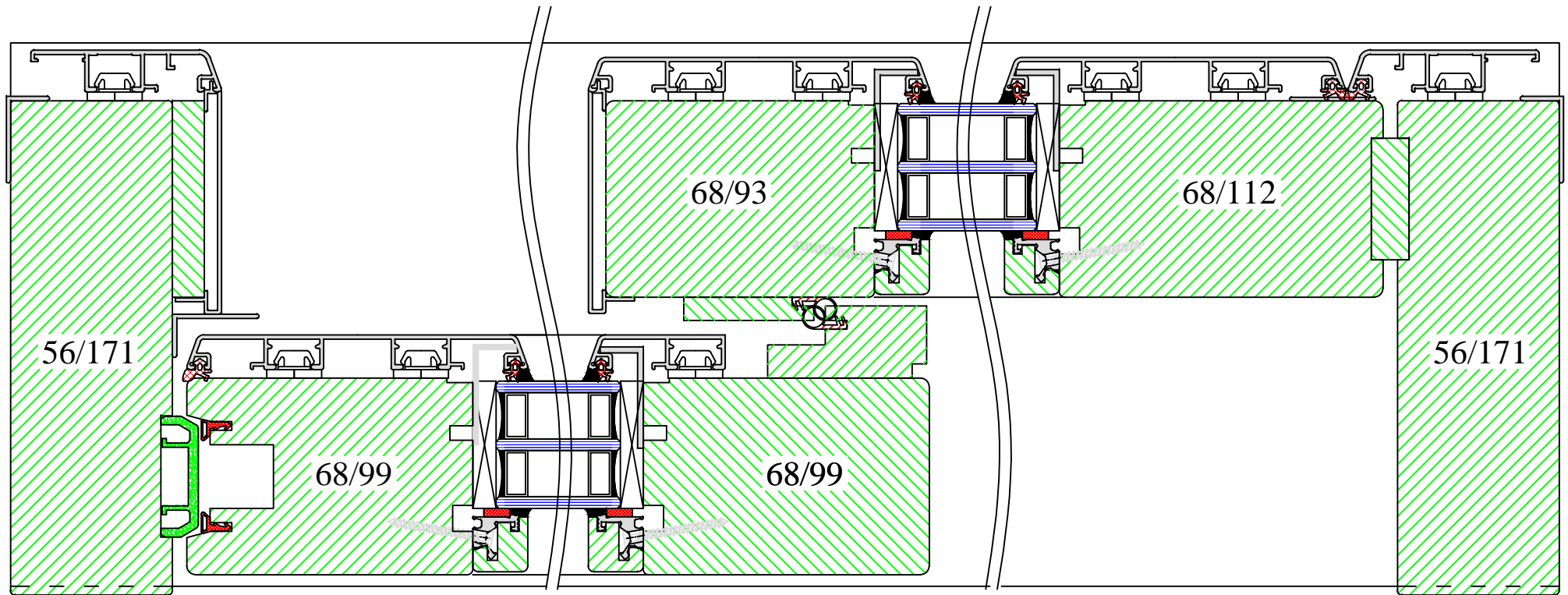

www.uniwin.co.uk



UNI WINDOWS Ltd.
 Unit 6, Edgefield Industrial Est.
 Loanhead, EH20 9TB
 Tel.: 0131 448 3931

MARCONI MAX 1 / 2
 Lift and slide patio door – horizontal cut

Version: 1	Scale: 1:2
Date: 15.05.14	Drawing: NEHS/2

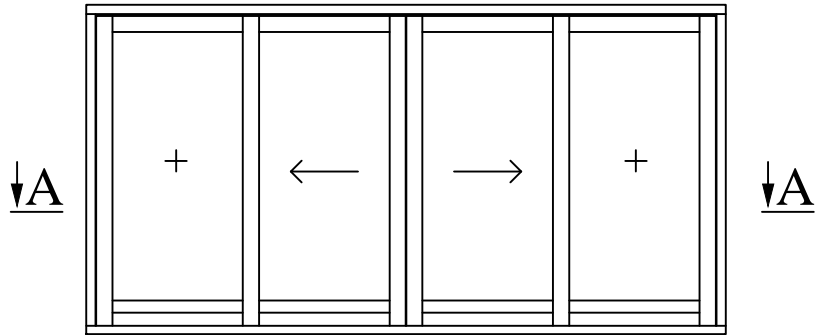

A-A

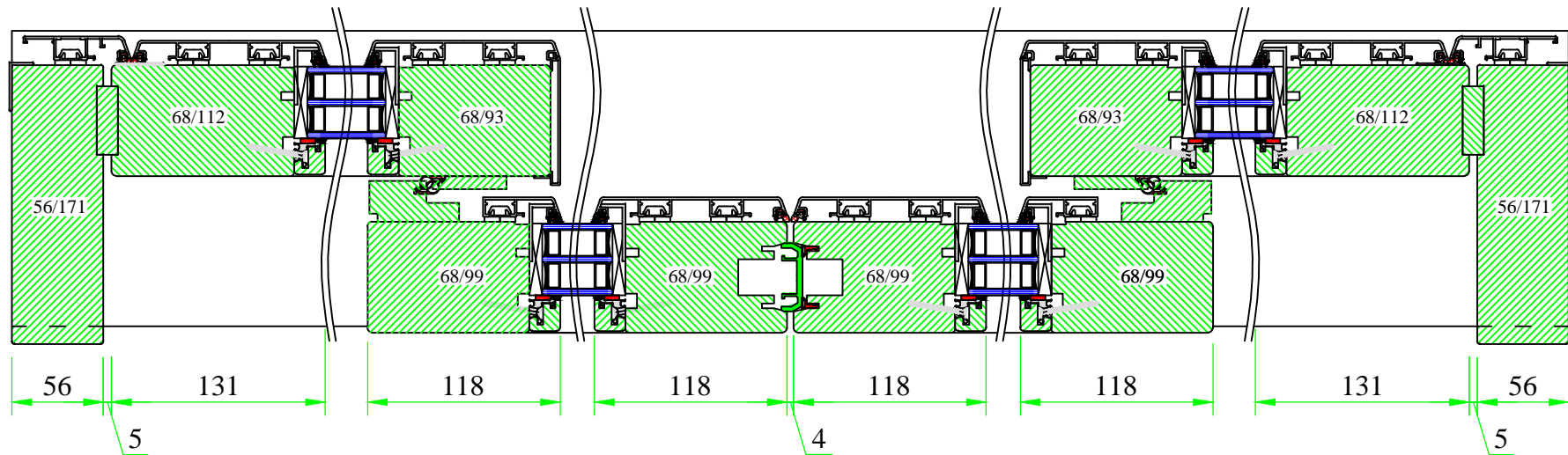

UNI WINDOWS Ltd.
 Unit 6, Edgefield Industrial Est.
 Loanhead, EH20 9TB
 Tel.: 0131 448 3931

MARCONI MAX 1 / 2
 Lift and slide patio door – horizontal cut –
 – type C

Version: 1	Scale: 1:4
Date: 15.05.14	Drawing: NEHS/4

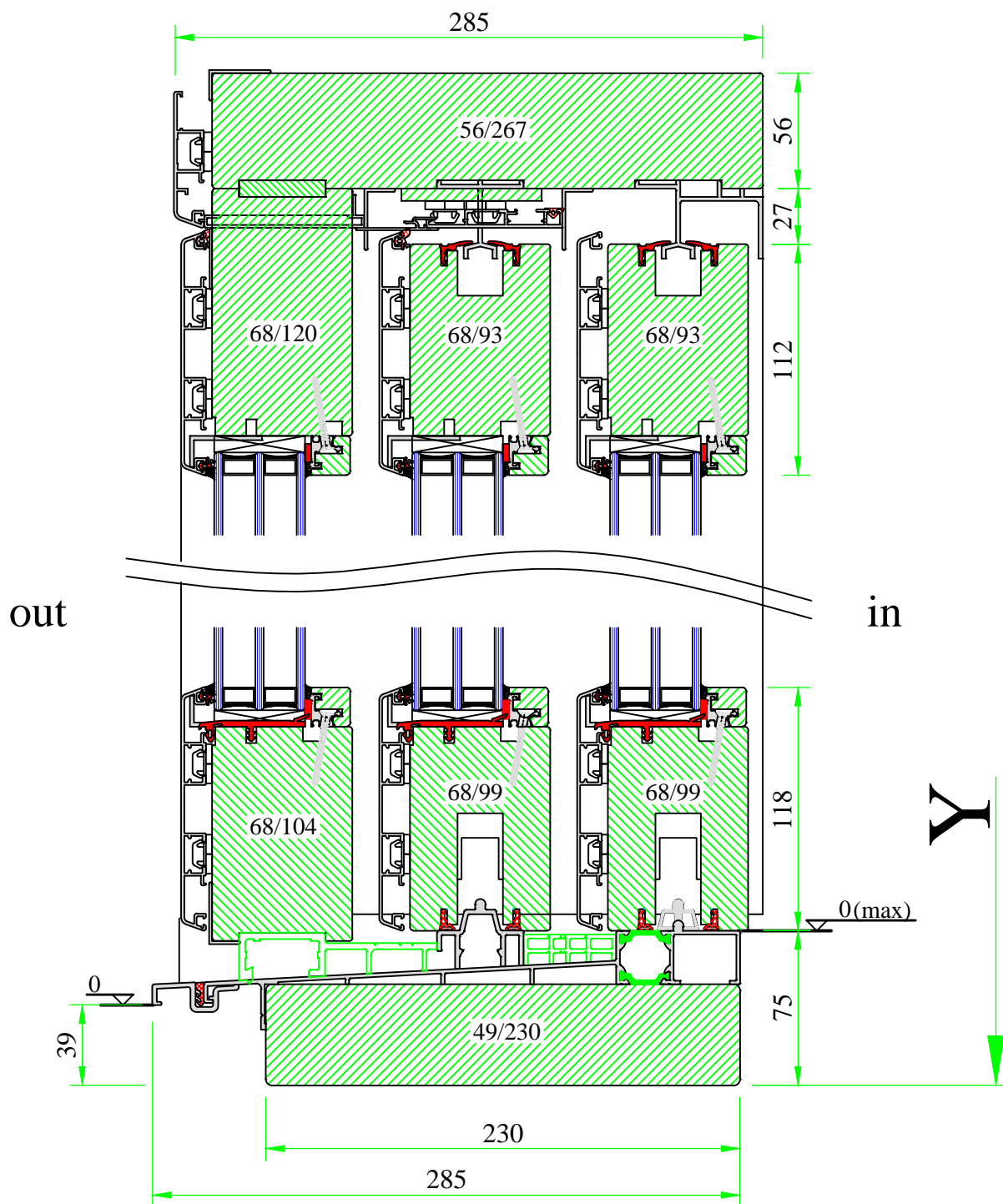
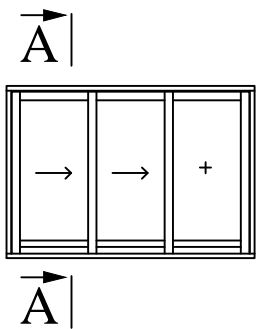

UNI WINDOWS Ltd.
 Unit 6, Edgefield Industrial Est.
 Loanhead, EH20 9TB
 Tel.: 0131 448 3931

MARCONI MAX 1/2
 Lift and slide patio door – vertical cut –
 – type E

Version:
1
 Date:
15.05.14

Scale:
1:3
 Drawing:
NEHS/5

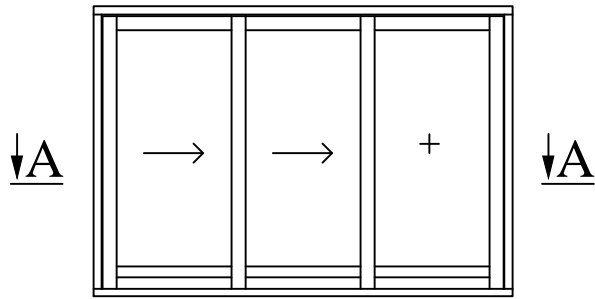

A-A

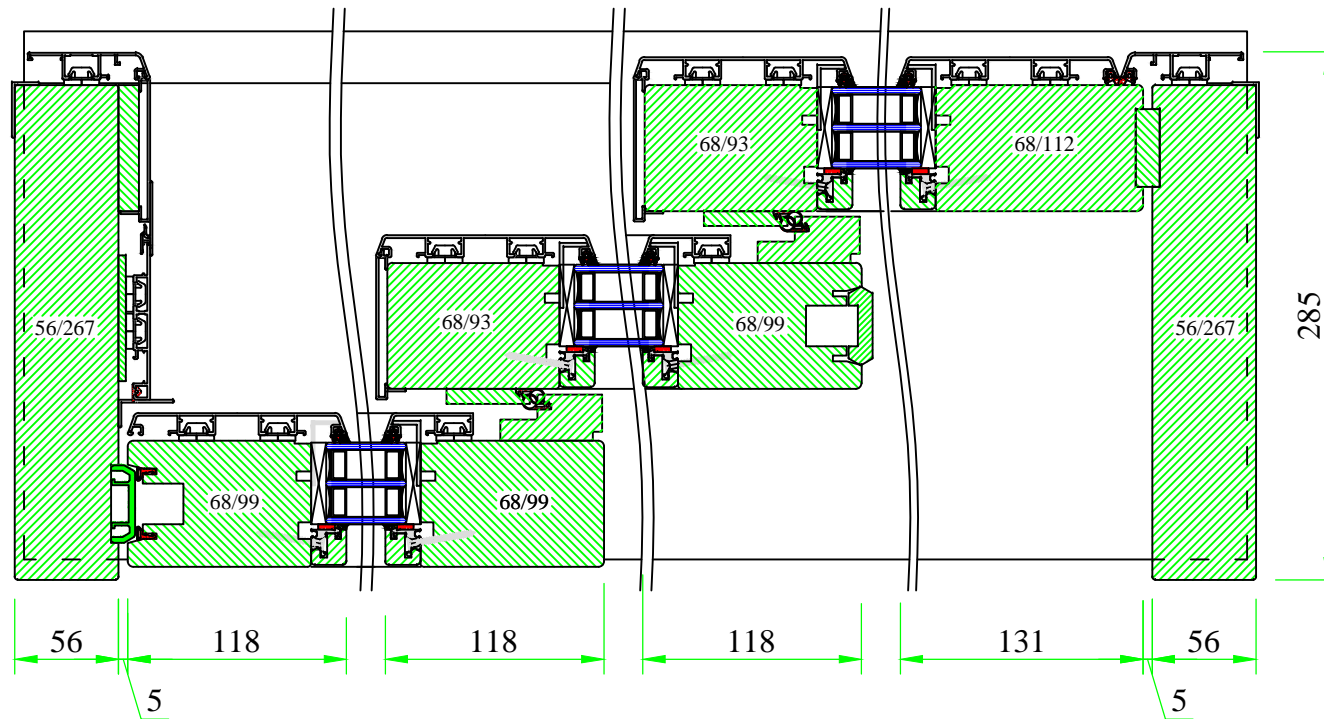

UNI WINDOWS Ltd.
 Unit 6, Edgefield Industrial Est.
 Loanhead, EH20 9TB
 Tel.: 0131 448 3931

MARCONI MAX 1 / 2
 Lift and slide patio door – horizontal cut –
 – type E

Version: 1	Scale: 1:4
Date: 15.05.14	Drawing: NEHS/6

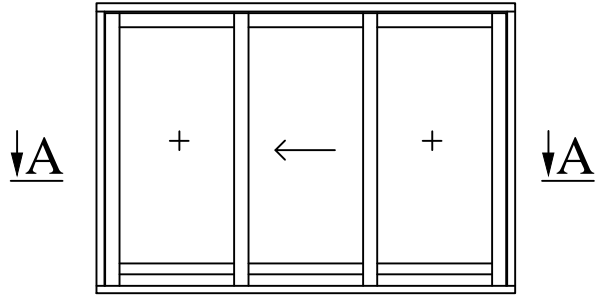

A-A

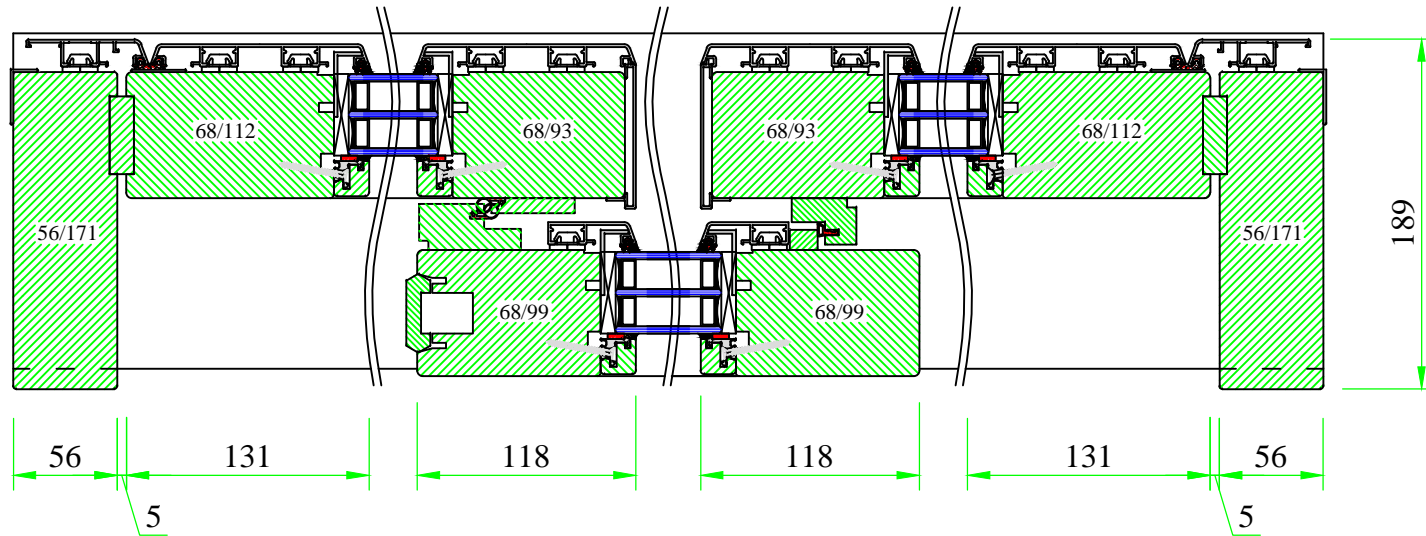

UNI WINDOWS Ltd.
 Unit 6, Edgefield Industrial Est.
 Loanhead, EH20 9TB
 Tel.: 0131 448 3931

MARCONI MAX 1 / 2
 Lift and slide patio door – horizontal cut –
 – type G

Version: 1	Scale: 1:4
Date: 15.05.14	Drawing: NEHS/7

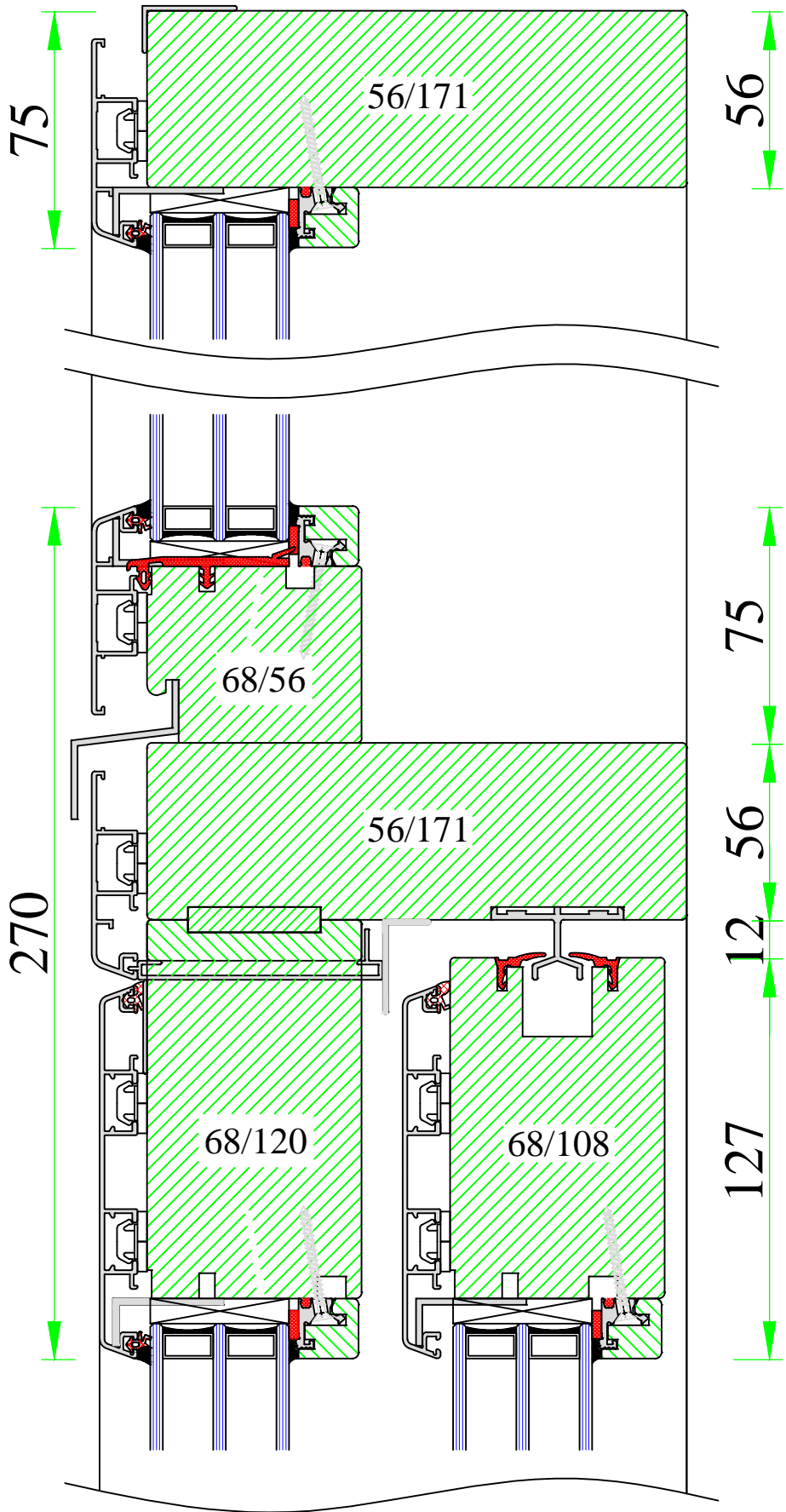
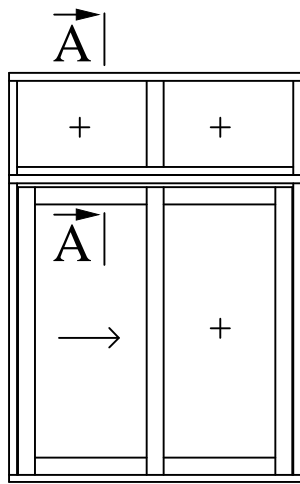

www.uniwin.co.uk



UNI WINDOWS Ltd.
 Unit 6, Edgefield Industrial Est.
 Loanhead, EH20 9TB
 Tel.: 0131 448 3931

MARCONI MAX 1 / 2
 Lift and slide patio door with fixed top light

Version: 1	Scale: 1:2
Date: 15.05.14	Drawing: NEHS/8

A

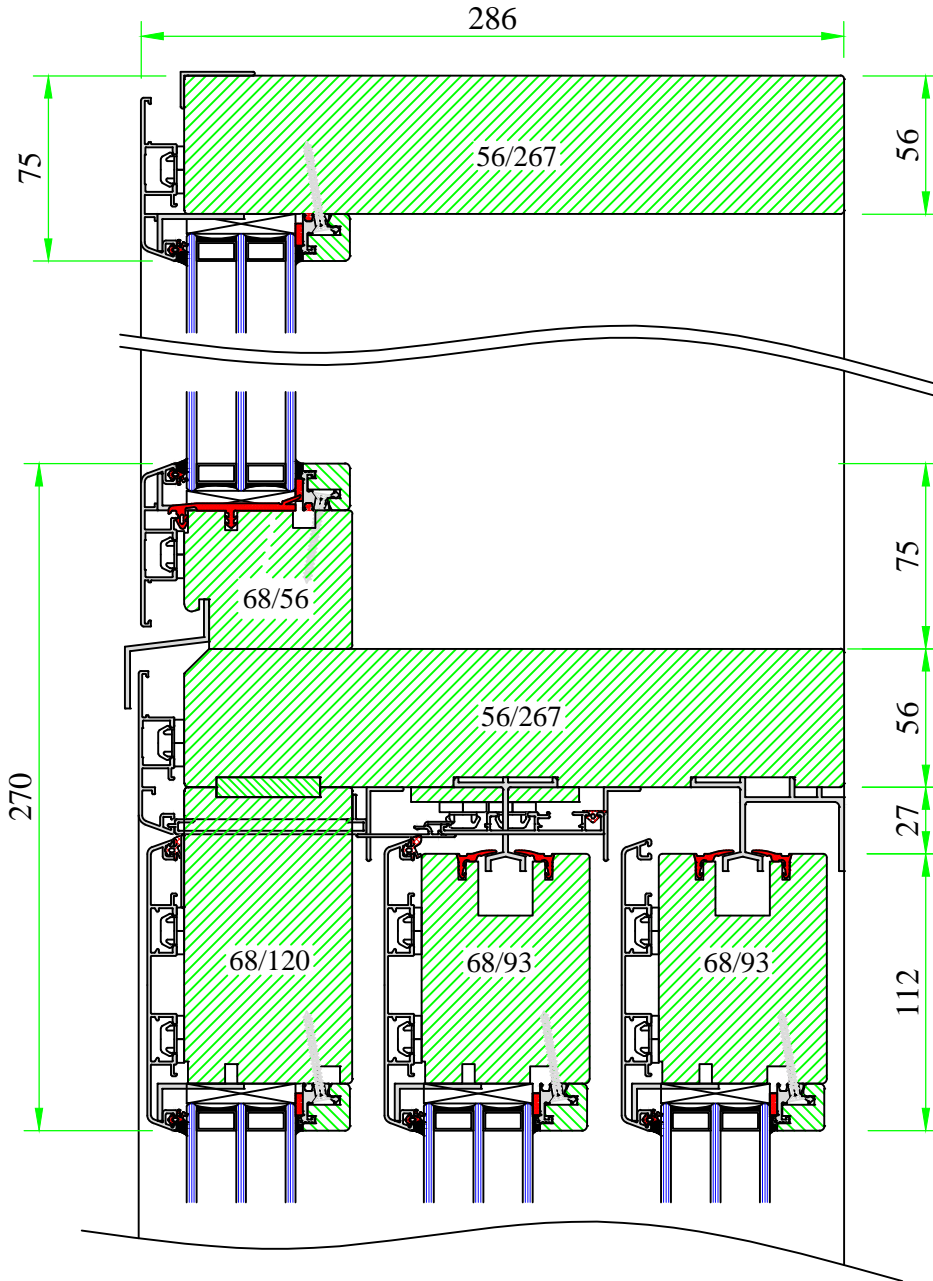
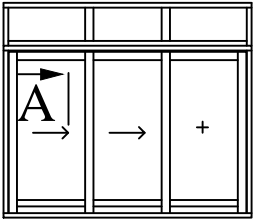

www.uniwin.co.uk



UNI WINDOWS Ltd.
 Unit 6, Edgefield Industrial Est.
 Loanhead, EH20 9TB
 Tel.: 0131 448 3931

MARCONI MAX 1 / 2

Lift and slide patio door type E with fixed top light

Version:
1

Scale:
1:3

Date:
15.05.14

Drawing:
NEHS/8-1

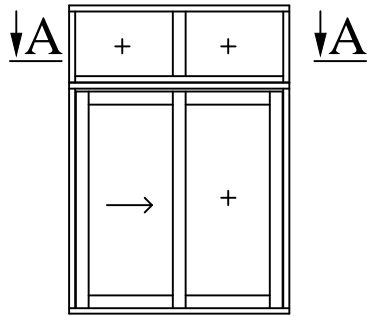

A-A

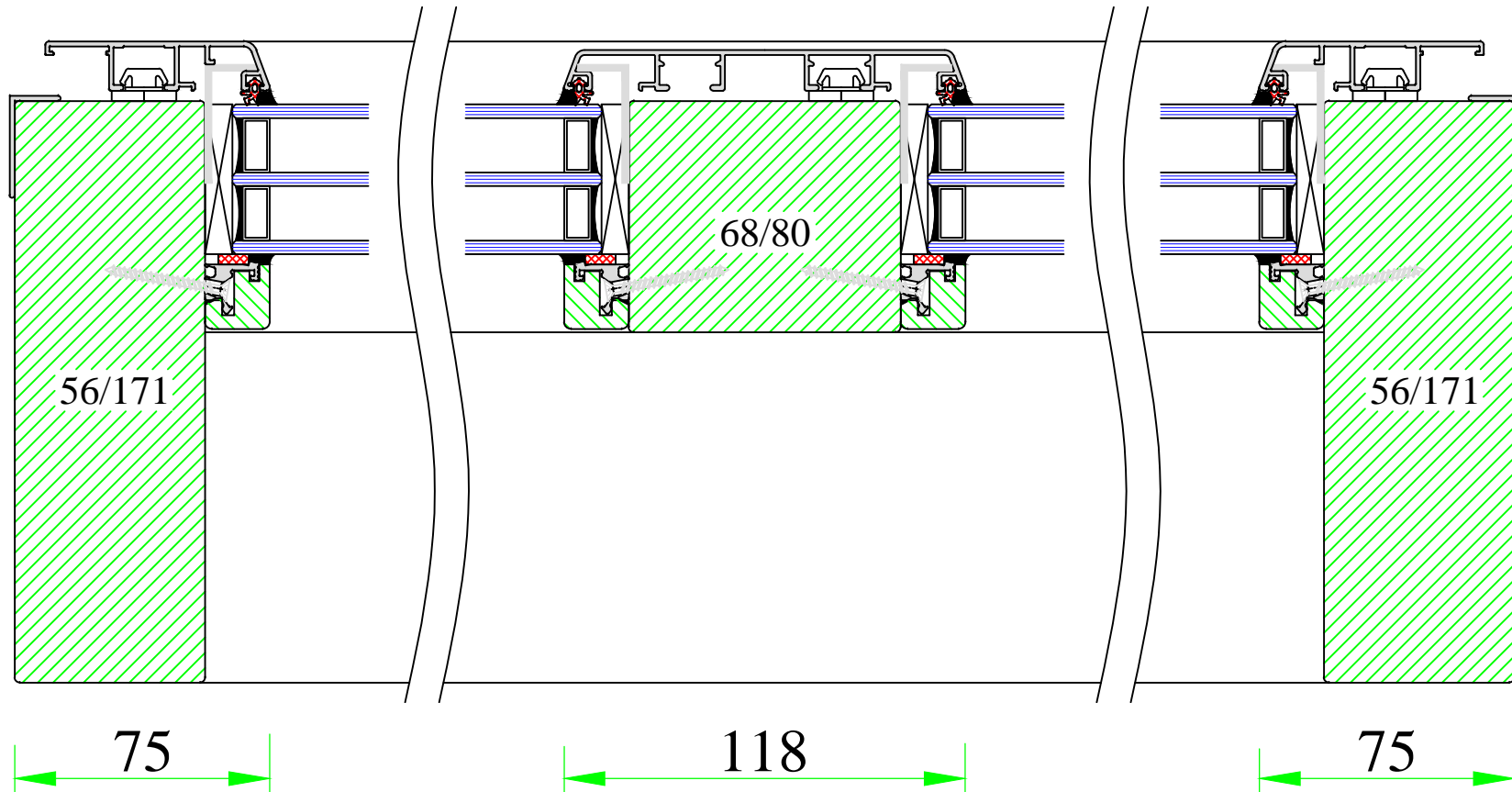

UNI WINDOWS Ltd.
 Unit 6, Edgefield Industrial Est.
 Loanhead, EH20 9TB
 Tel.: 0131 448 3931

MARCONI MAX 1/ 2
 Lift and slide patio door with fixed top light

Version: 1	Scale: 1:2
Date: 15.05.14	Drawing: NEHS/9

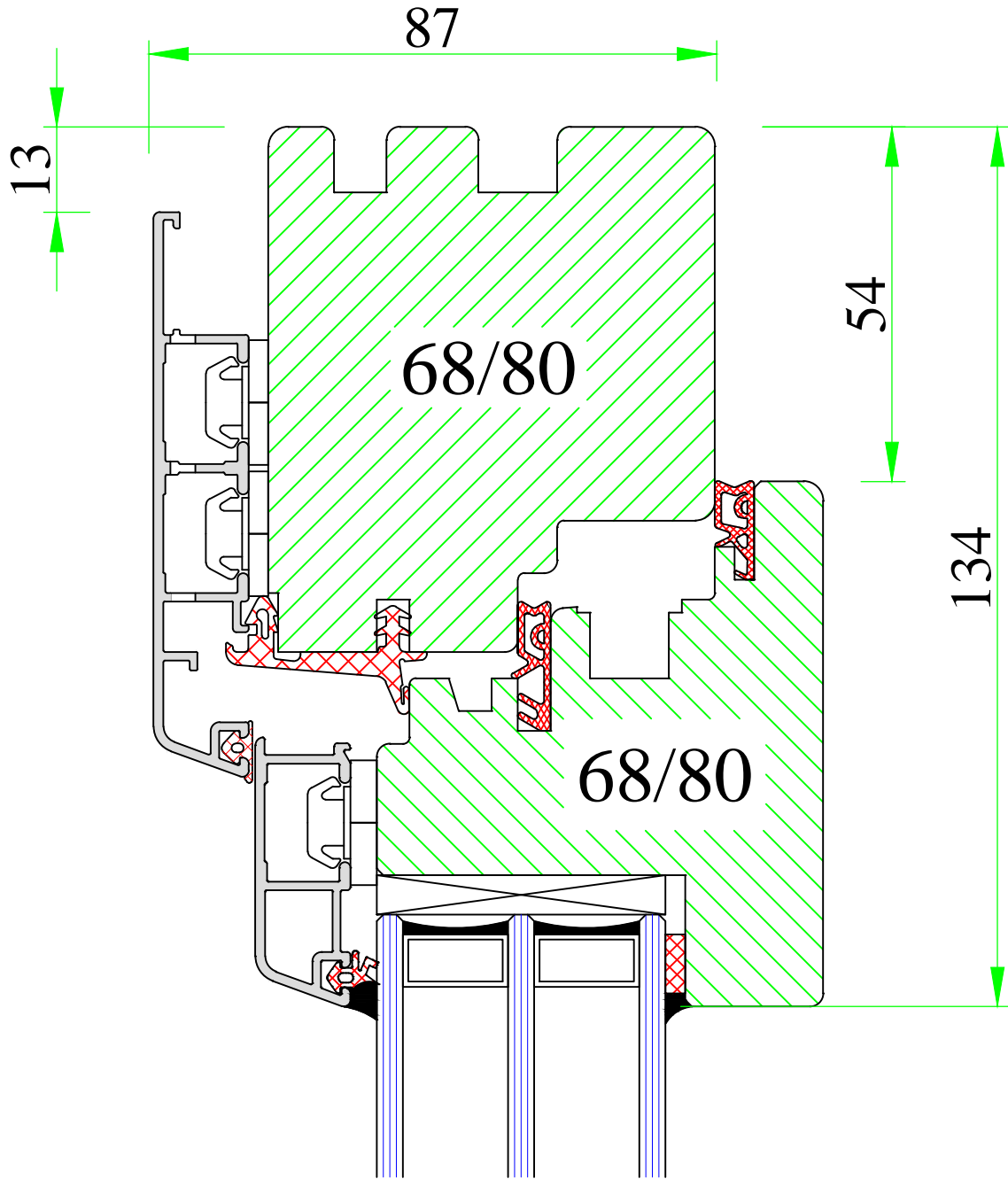
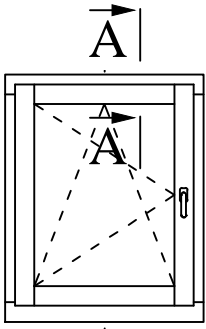

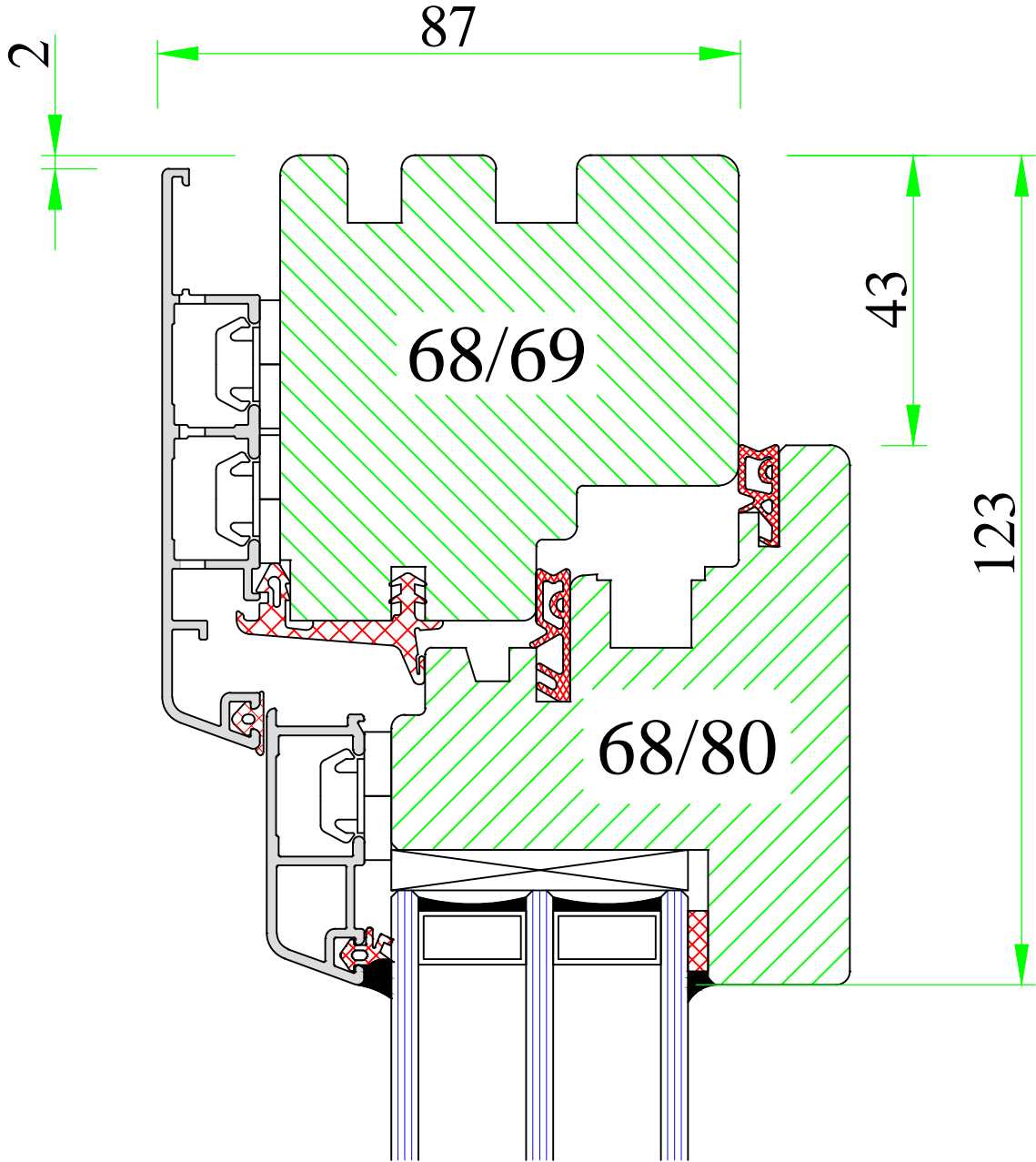
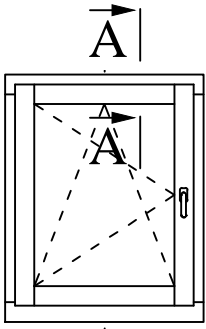

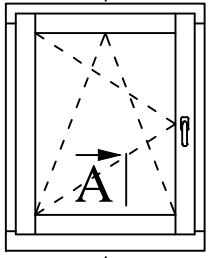

A

NE/2

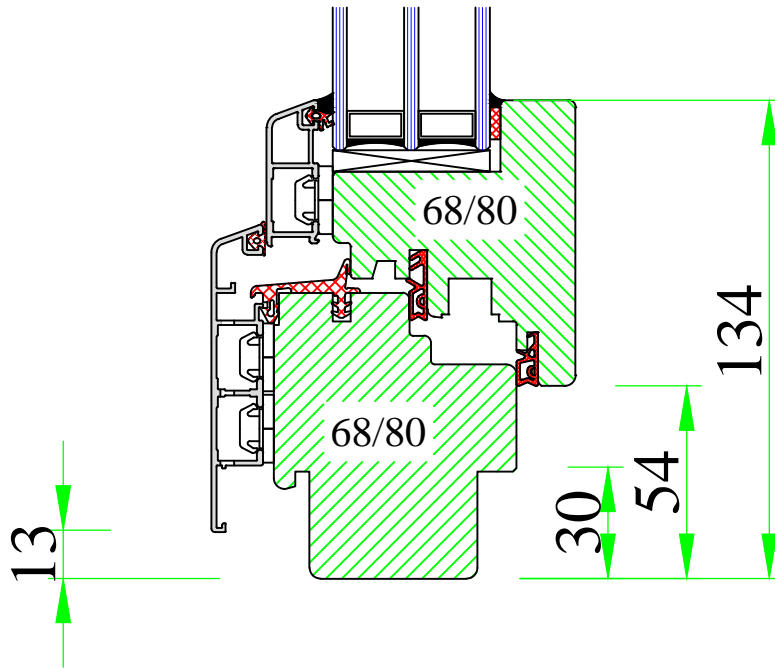

NE/2/1

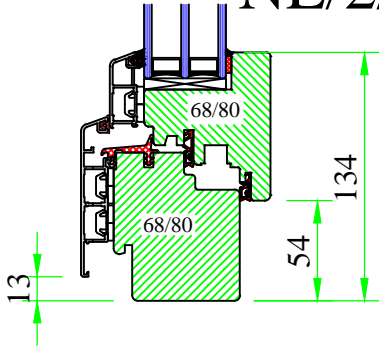

NE/2/2

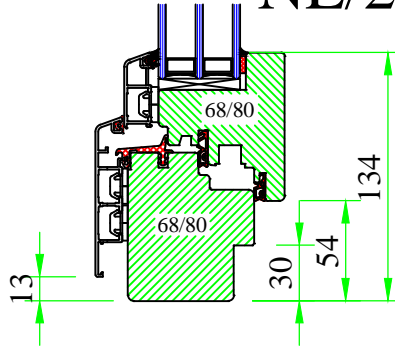

NE/2/3

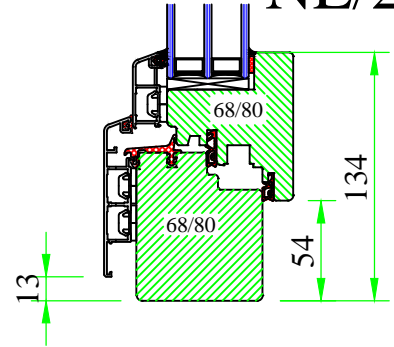

UNI WINDOWS Ltd.
 Unit 6, Edgefield Industrial Est.
 Loanhead, EH20 9TB
 Tel.: 0131 448 3931

MARCONI MAX

Frame-sash connection – bottom

Version:
1

Date:
15.05.14

Scale:
1:2

Drawing:
NE/2

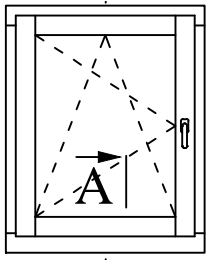

A

2

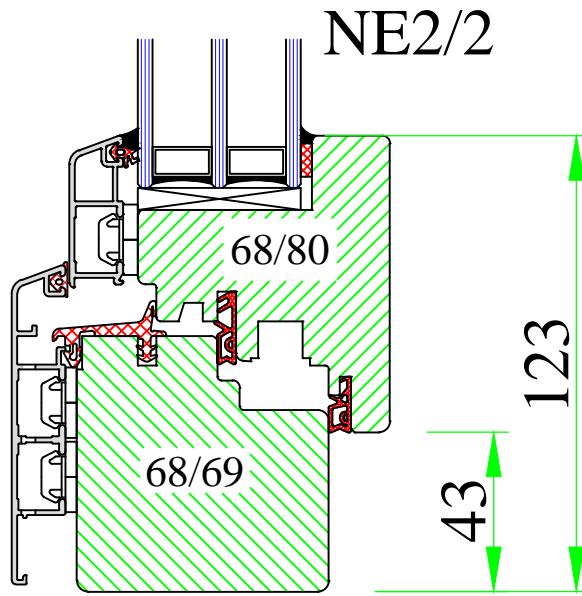

NE2/2/1

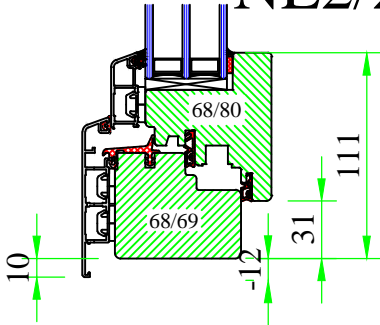

NE2/2/2

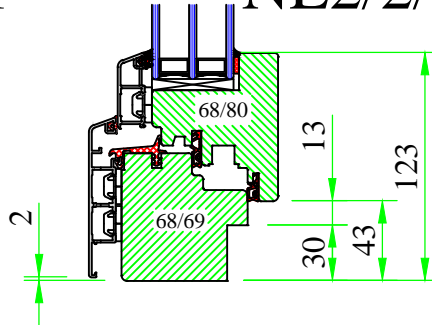

NE2/2/3

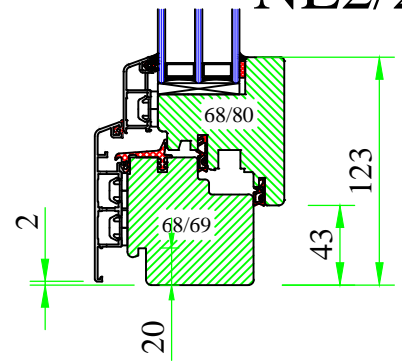

NE2/2/4

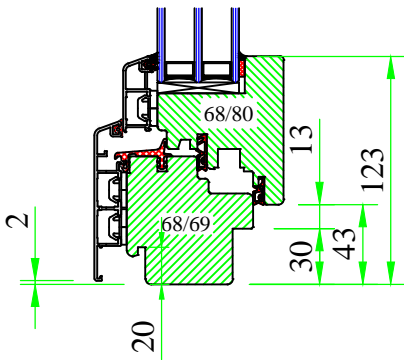

NE2/2/5

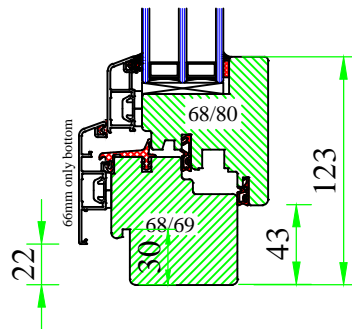

UNI WINDOWS Ltd.
Unit 6, Edgefield Industrial Est.
Loanhead, EH20 9TB
Tel.: 0131 448 3931

MARCONI MAX 2
Frame-sash connection – bottom

Version: 1	Scale: 1:2
Date: 15.05.14	Drawing: NE2/2

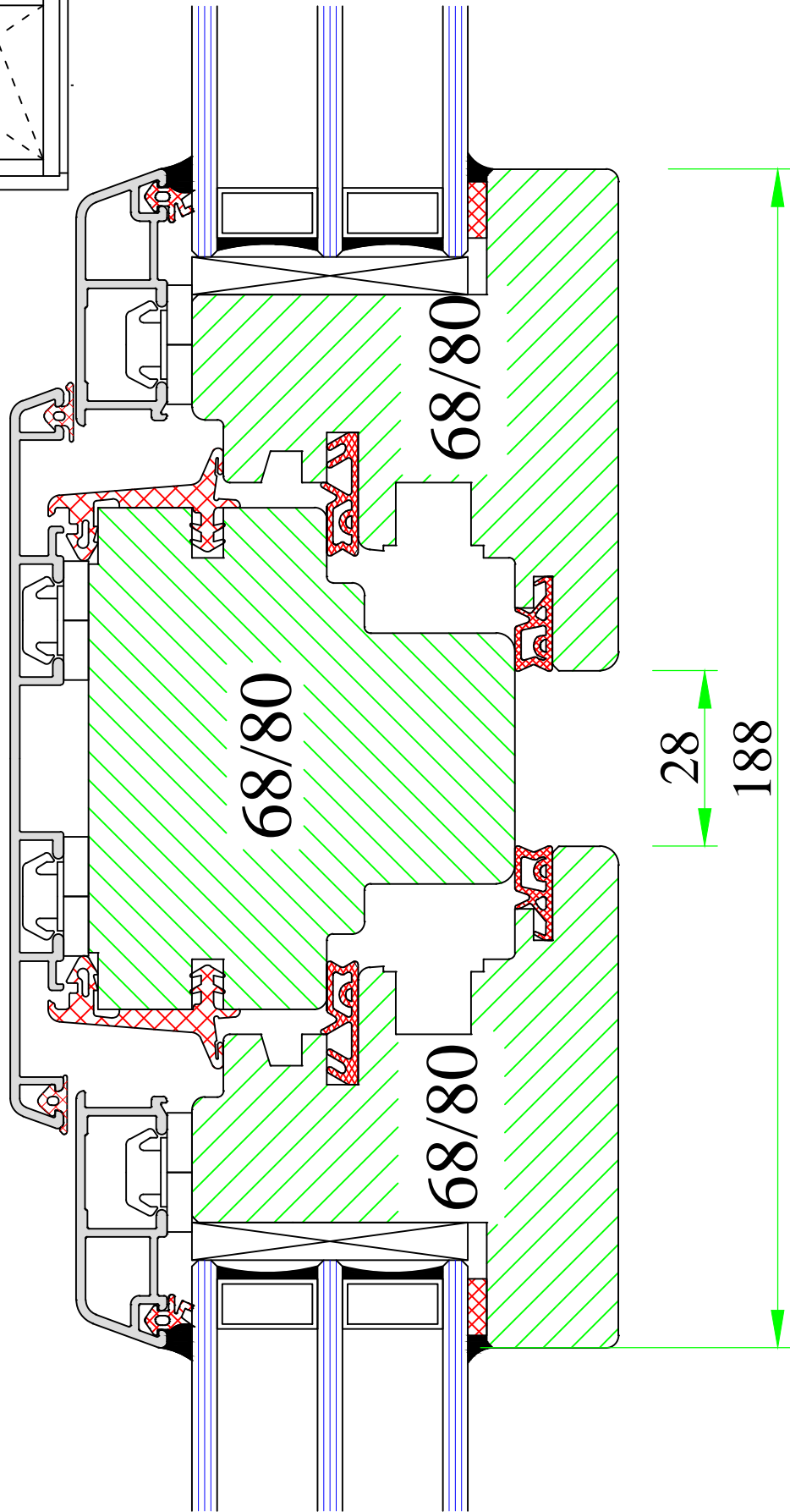
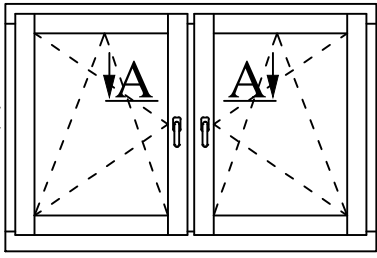

UNI WINDOWS Ltd.
 Unit 6, Edgefield Industrial Est.
 Loanhead, EH20 9TB
 Tel.: 0131 448 3931

MARCONI MAX 1 / 2

Double opening window fixed mullion 80mm

Version:
1

Scale:
1:1

Date:
15.05.14

Drawing:
NE/3

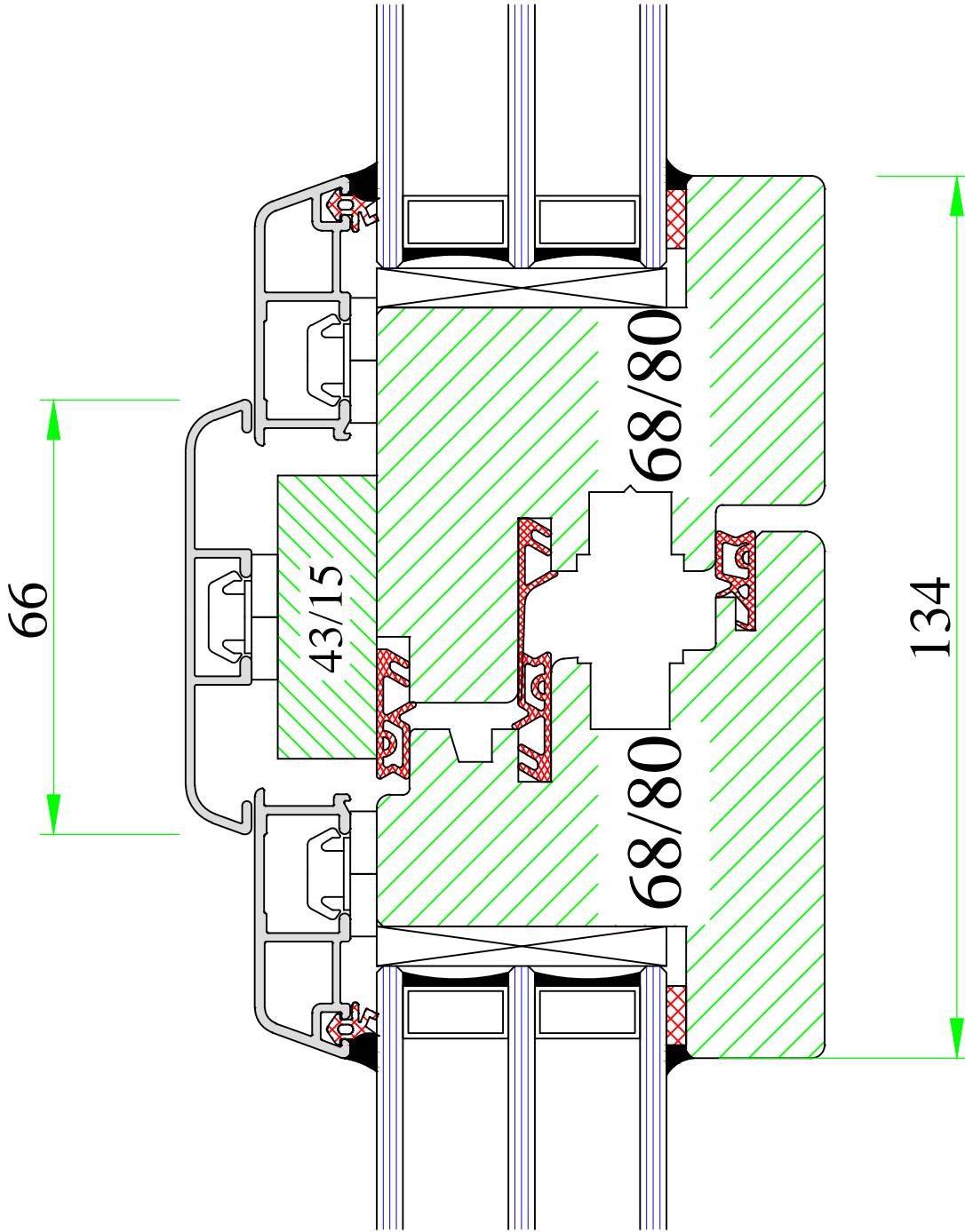
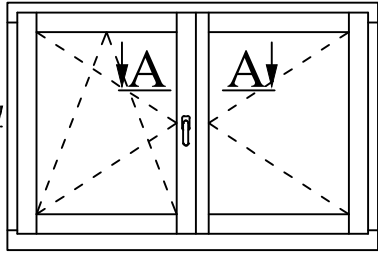

UNI WINDOWS Ltd.
 Unit 6, Edgefield Industrial Est.
 Loanhead, EH20 9TB
 Tel.: 0131 448 3931

"Flying" mullion

MARCONI MAX 1 / 2

Version:
1

Scale:
1:1

Date:
15.05.14

Drawing:
NE/5

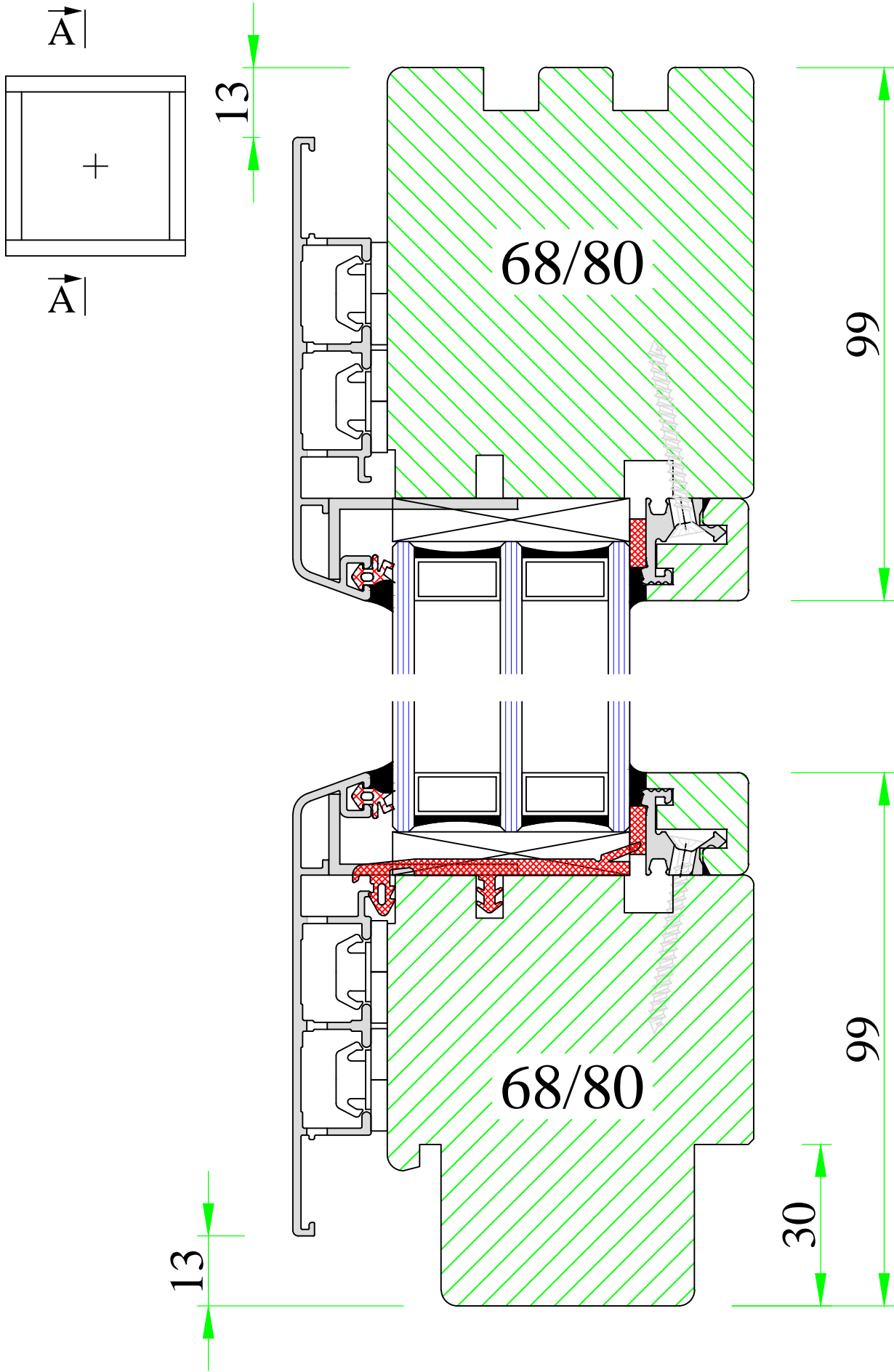

UNI WINDOWS Ltd.
 Unit 6, Edgefield Industrial Est.
 Loanhead, EH20 9TB
 Tel.: 0131 448 3931

Fixed glazing

MARCONI MAX

Version:
1

Scale:
1:1

Date:
15.05.14

Drawing:
NE/6

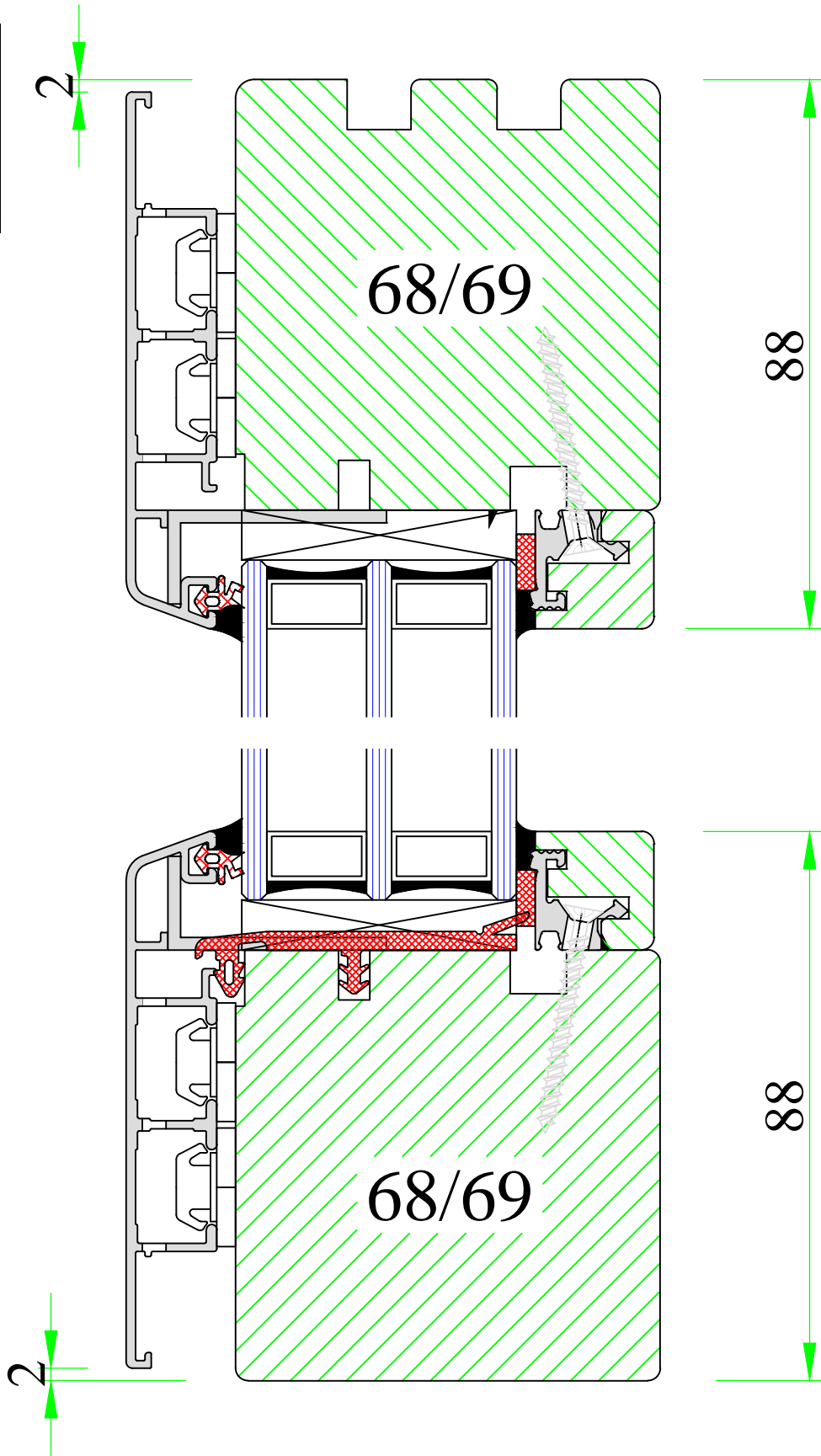
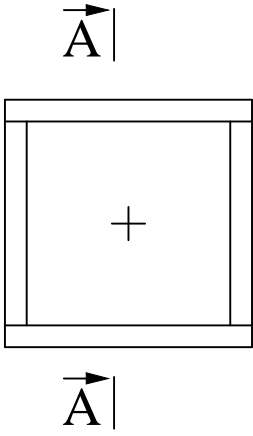

UNI WINDOWS Ltd.
 Unit 6, Edgefield Industrial Est.
 Loanhead, EH20 9TB
 Tel.: 0131 448 3931

Fixed glazing

MARCONI MAX 2

Version:
1

Scale:
1:1

Date:
15.05.14

Drawing:
NE2/6

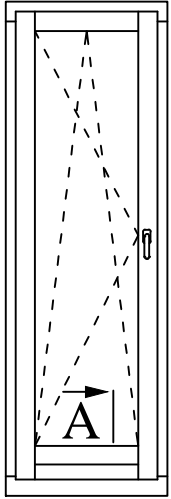

A

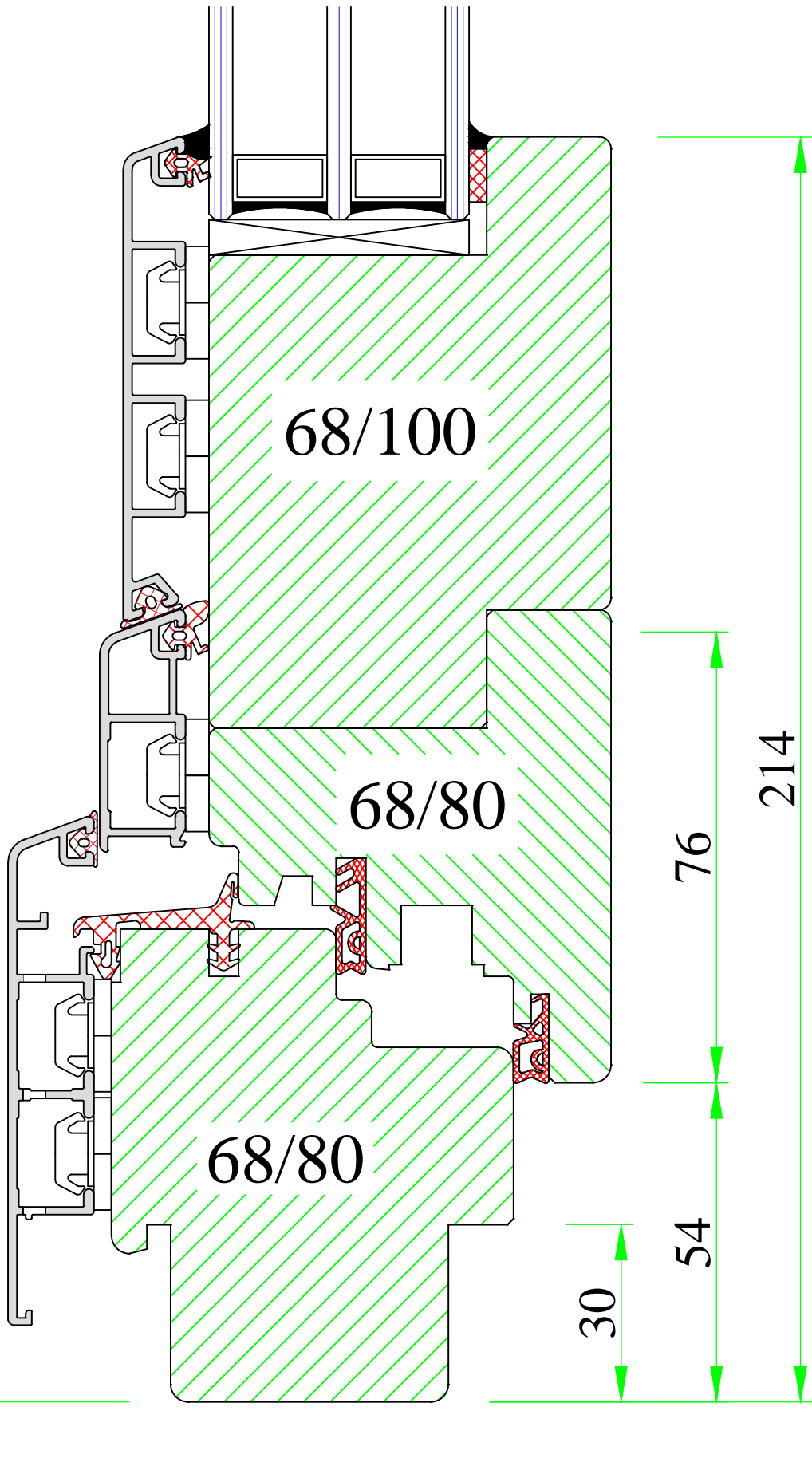

UNI WINDOWS Ltd.
 Unit 6, Edgefield Industrial Est.
 Loanhead, EH20 9TB
 Tel.: 0131 448 3931

MARCONI MAX

Frame-sash connection –bottom of
 balcony door

Version:
 1
 Date:
 15.05.14

Scale:
 1:1
 Drawing:
 NE/7

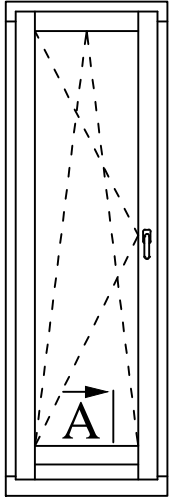

A

2

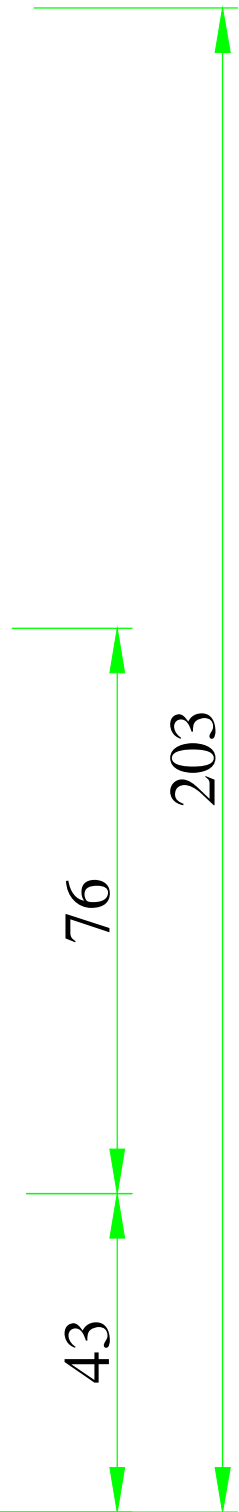
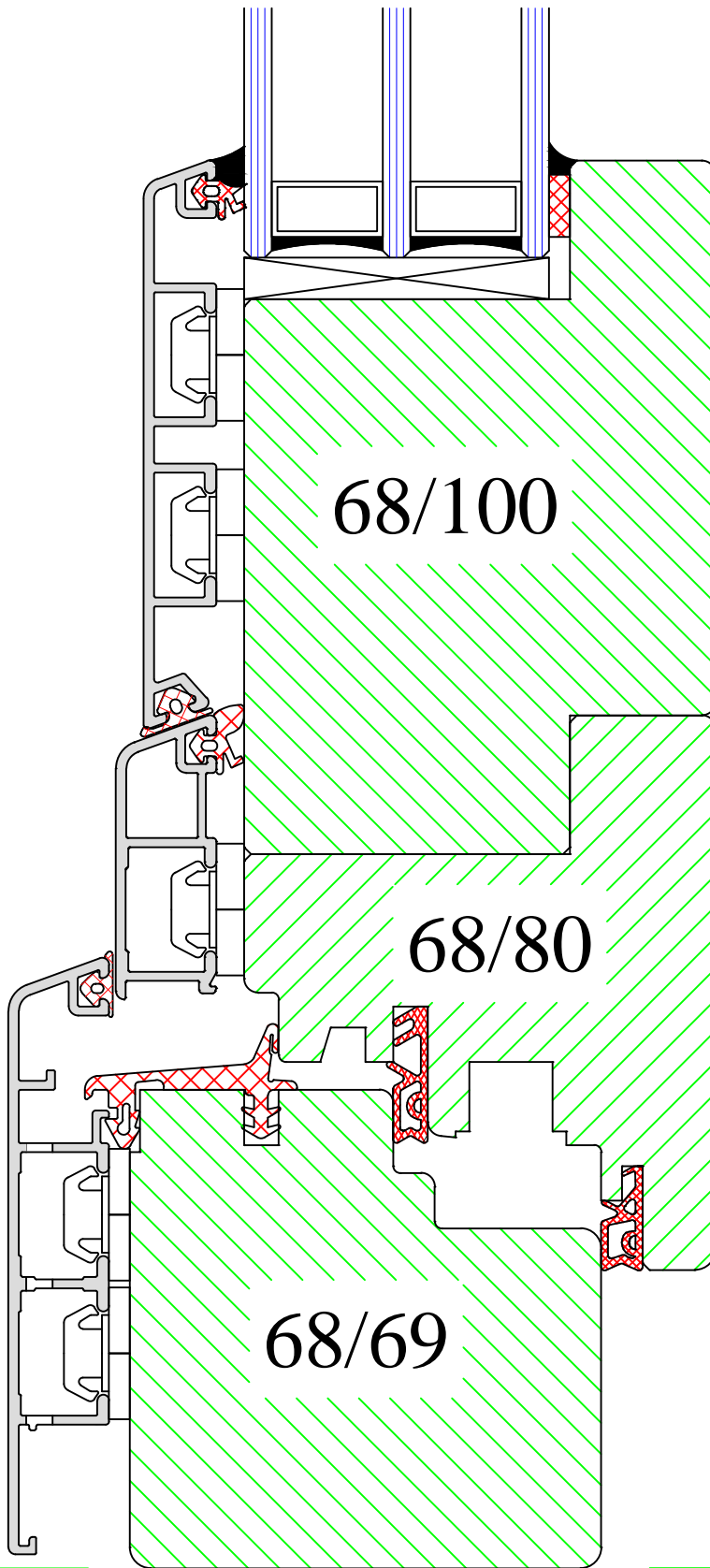

68/100

68/80

68/69

203

76

43



UNI WINDOWS Ltd.
 Unit 6, Edgefield Industrial Est.
 Loanhead, EH20 9TB
 Tel.: 0131 448 3931

MARCONI MAX 2
 Frame-sash connection – bottom of
 balcony door

Version:
1
 Date:
15.05.14

Scale:
1:1
 Drawing:
NE2/7

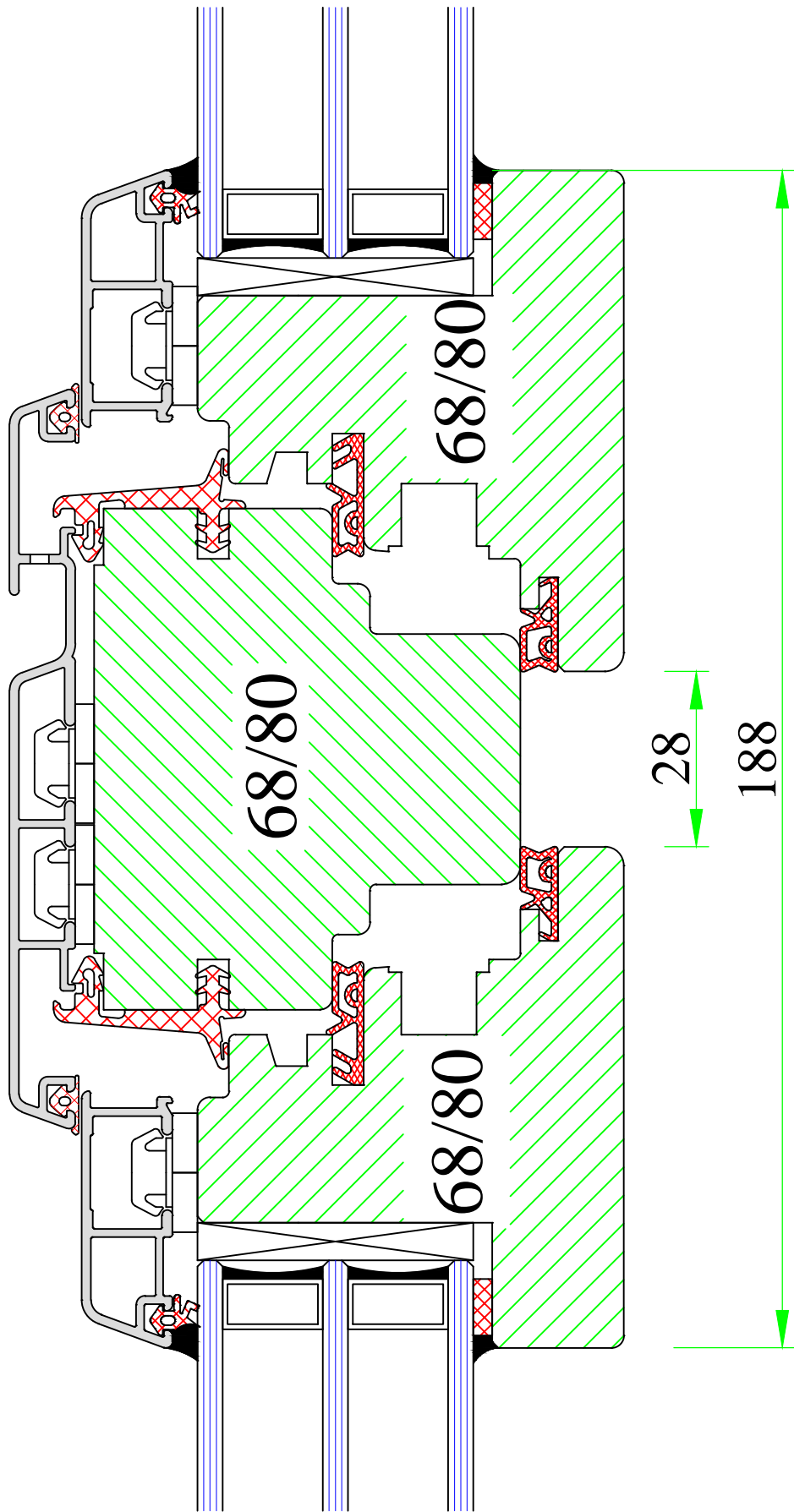
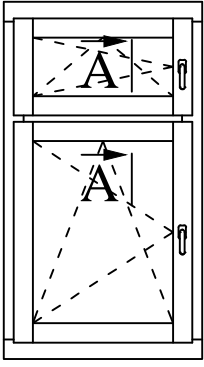

UNI WINDOWS Ltd.
 Unit 6, Edgefield Industrial Est.
 Loanhead, EH20 9TB
 Tel.: 0131 448 3931

MARCONI MAX 1 / 2
 Bottom and top sash – transom 80mm

Version: 1	Scale: 1:1
Date: 15.05.14	Drawing: NE/8

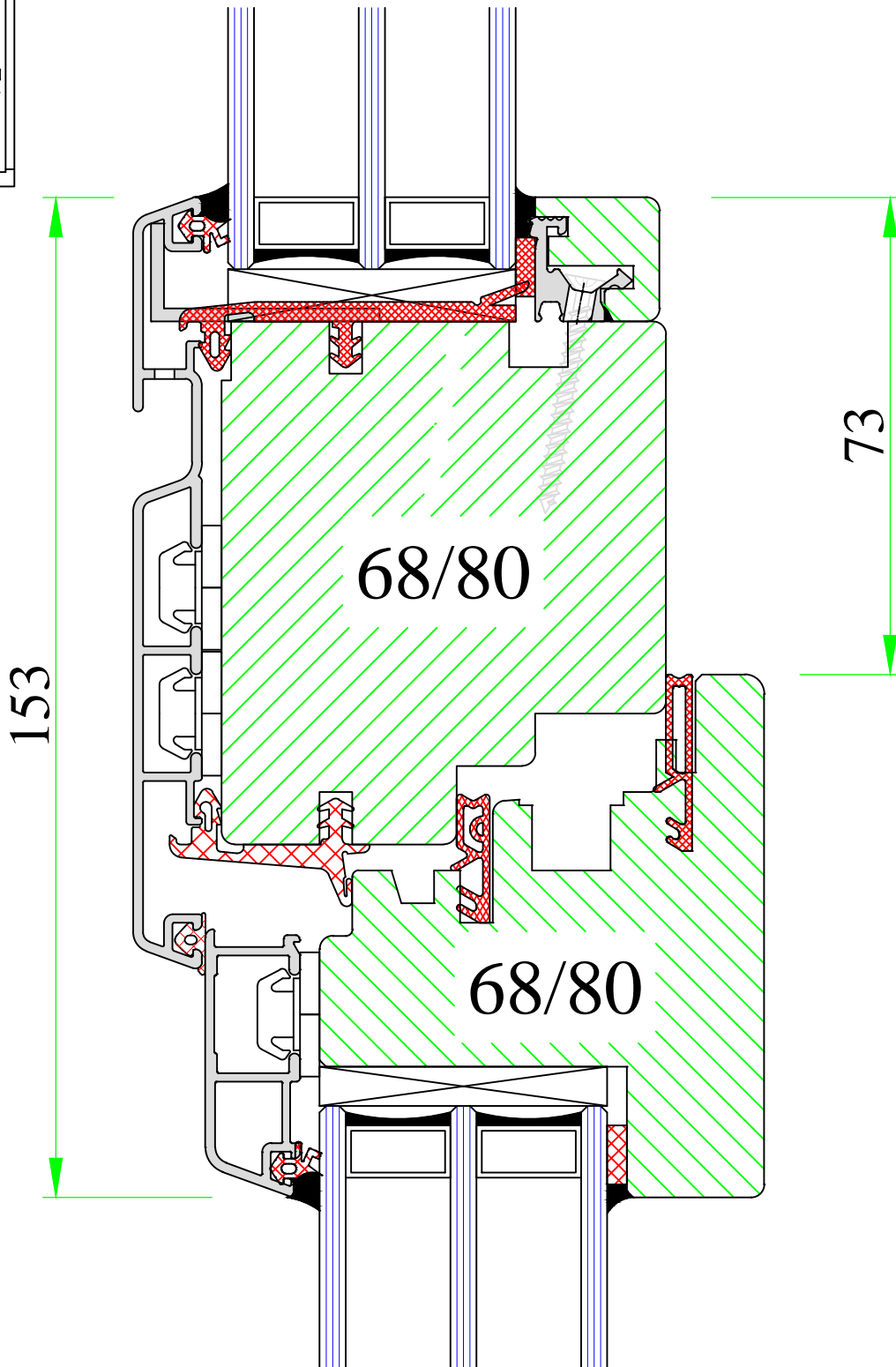
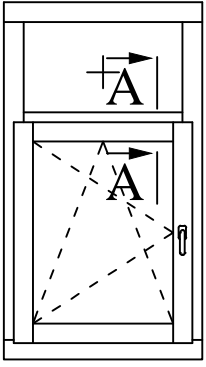

www.uniwin.co.uk



UNI WINDOWS Ltd.
 Unit 6, Edgefield Industrial Est.
 Loanhead, EH20 9TB
 Tel.: 0131 448 3931

MARCONI MAX 1/ 2
 Tilt & turn window with fixed top light

Version: 1	Scale: 1:1
Date: 15.05.14	Drawing: NE/9

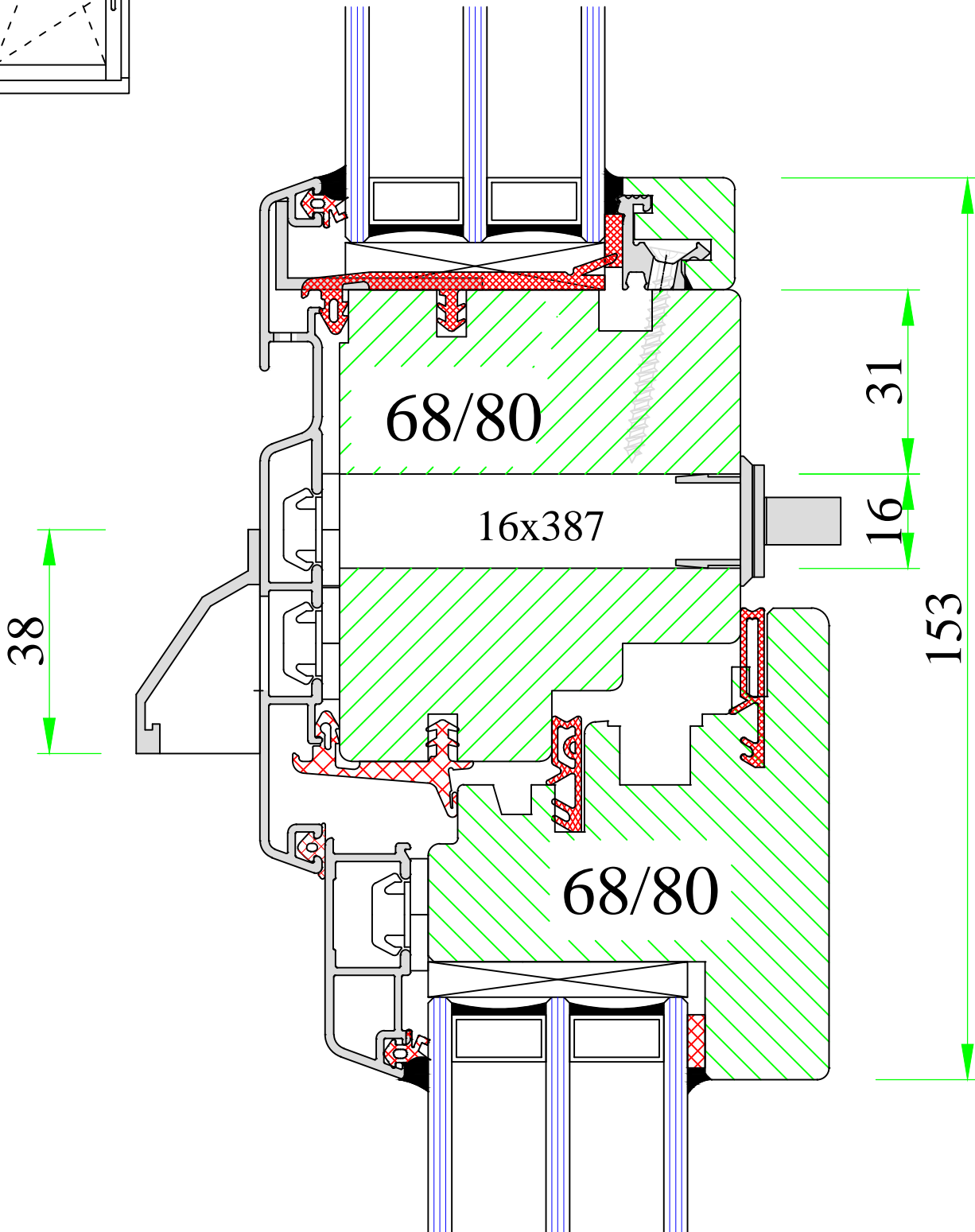
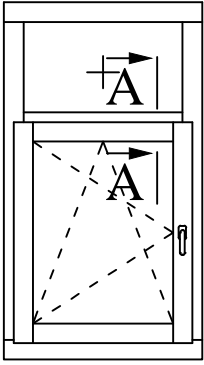

UNI WINDOWS Ltd.
 Unit 6, Edgefield Industrial Est.
 Loanhead, EH20 9TB
 Tel.: 0131 448 3931

Ventilator TV-90

MARCONI MAX 1 / 2

Version:
1

Scale:
1:1

Date:
15.05.14

Drawing:
NE/9-1

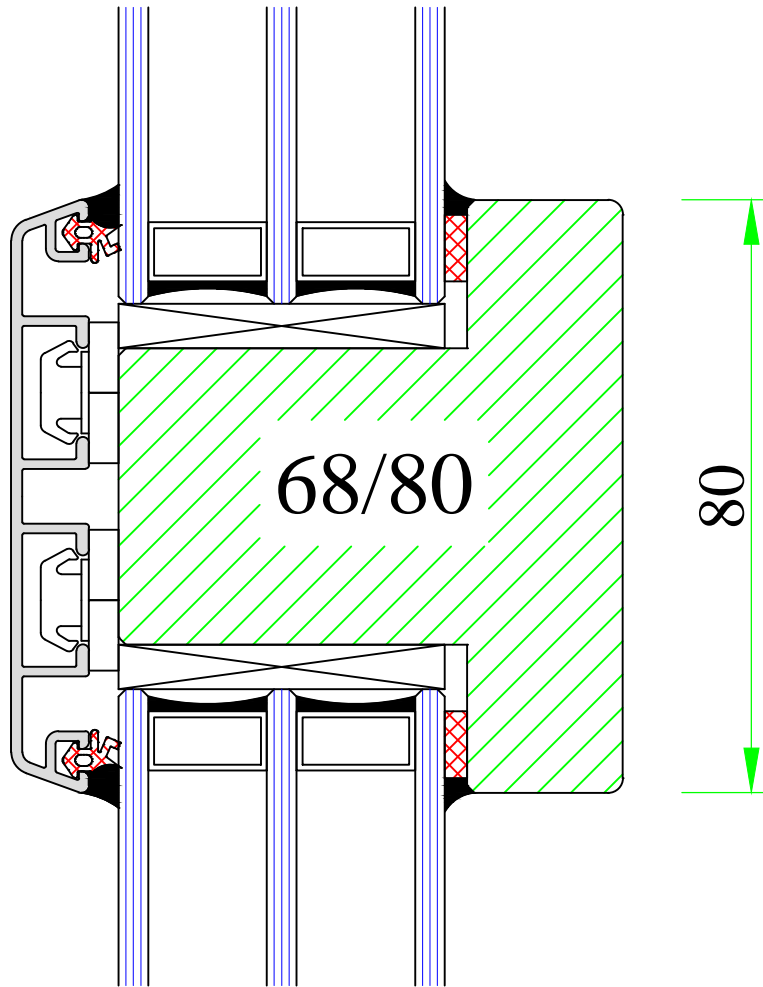
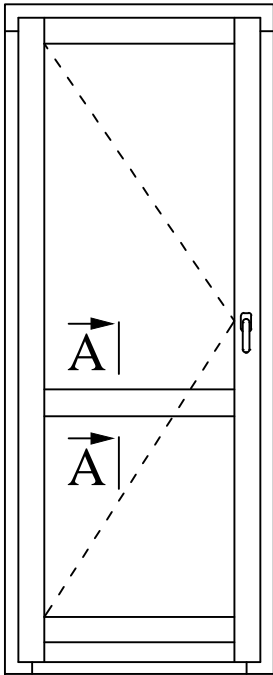

UNI WINDOWS Ltd.
 Unit 6, Edgefield Industrial Est.
 Loanhead, EH20 9TB
 Tel.: 0131 448 3931

MARCONI MAX 1 / 2
 Astragal construction in 80 mm profile

Version:
1
 Date:
15.05.14

Scale:
1:1
 Drawing:
NE/13

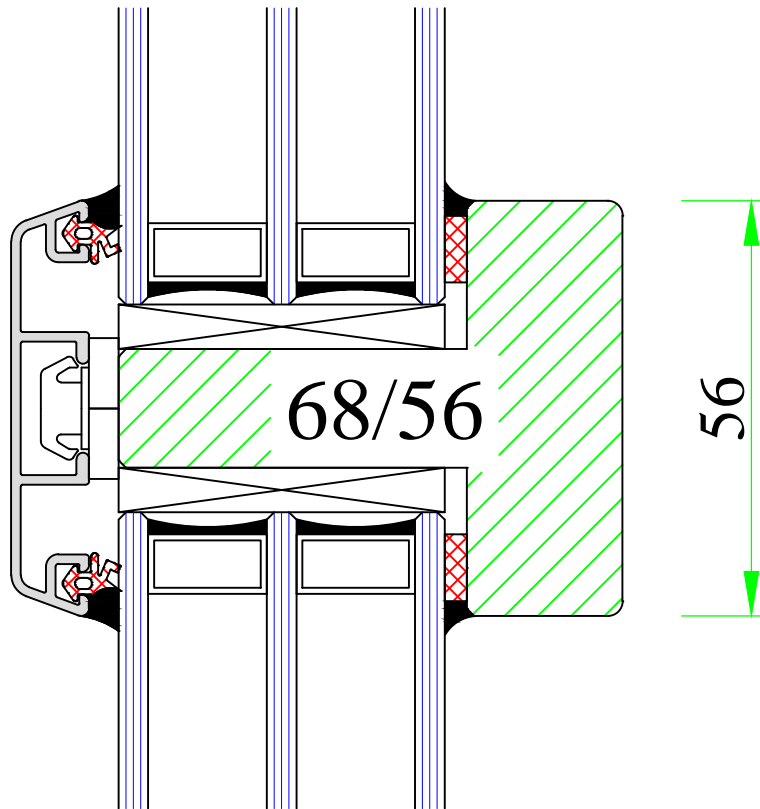
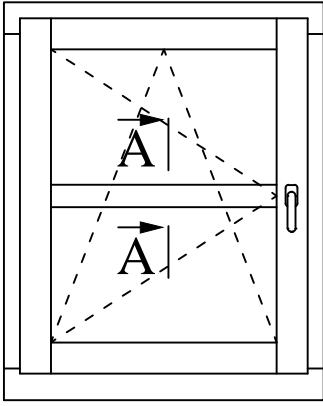

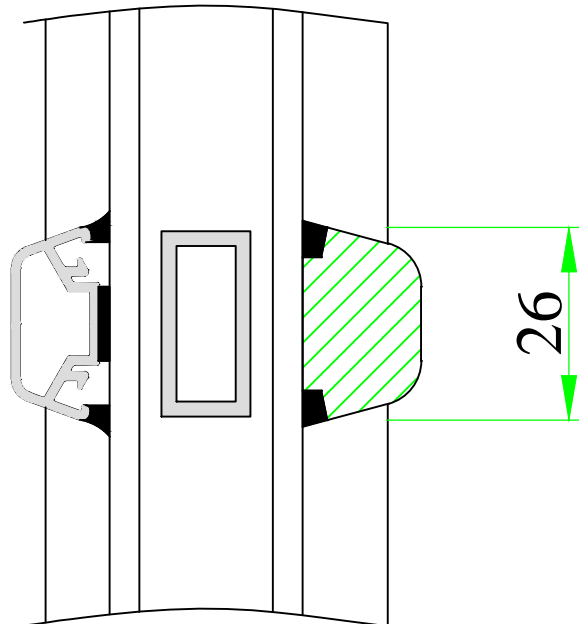
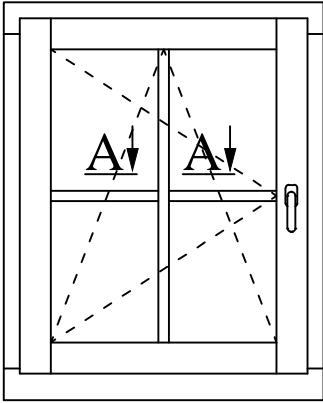

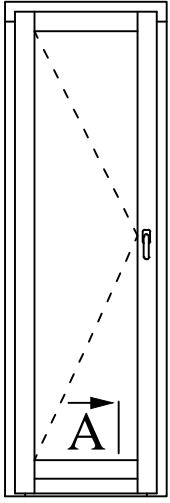

A

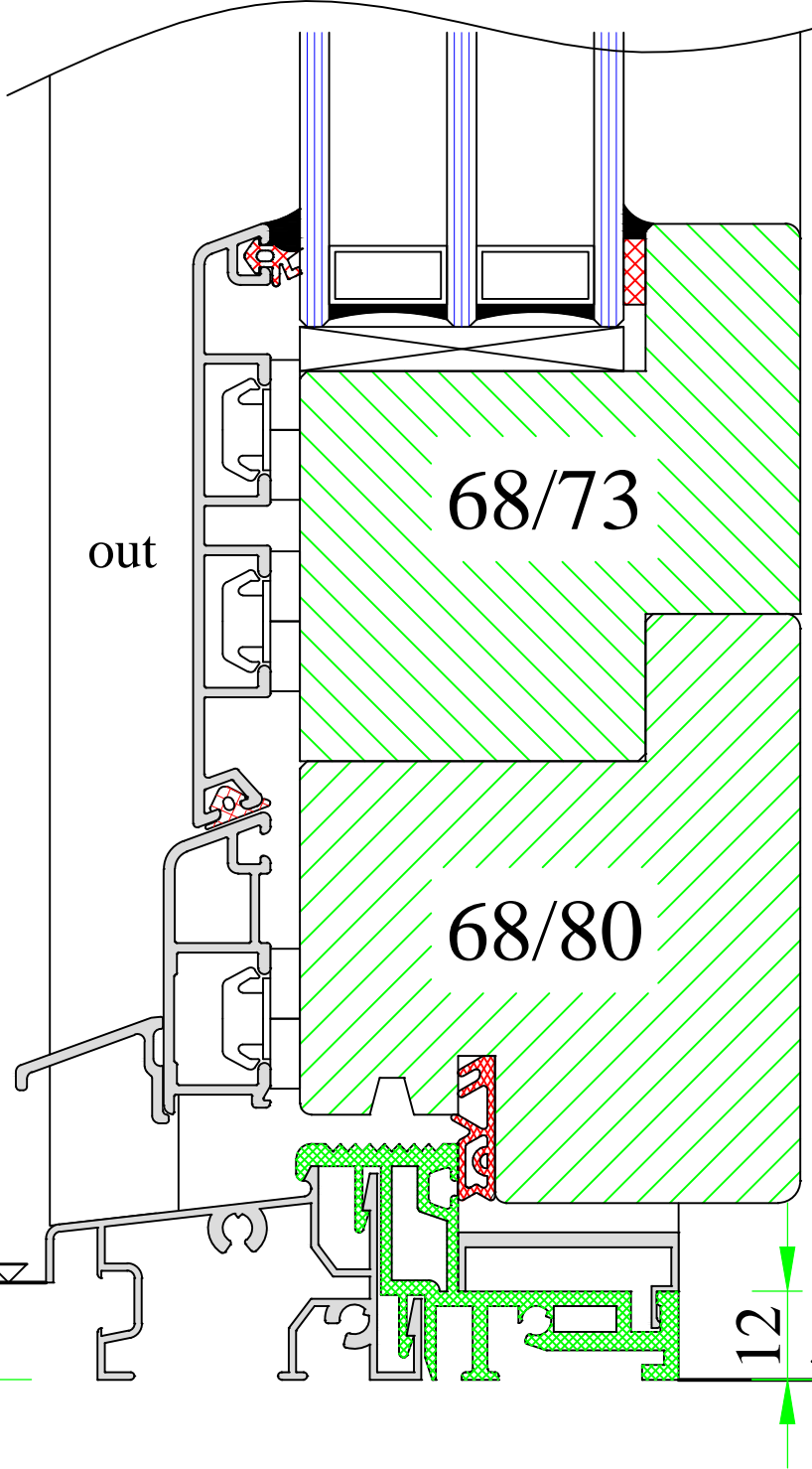

out

68/73

in

157

Y

68/80

13

0

12

0

24



UNI WINDOWS Ltd.
 Unit 6, Edgefield Industrial Est.
 Loanhead, EH20 9TB
 Tel.: 0131 448 3931

MARCONI MAX 1 / 2

Balcony door with flat threshold

Version:
1

Scale:
1:1

Date:
15.05.14

Drawing:
NE/18

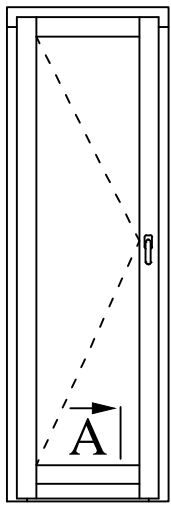

A

out

68/91

in

157

68/80

Y

14

6

0



UNI WINDOWS Ltd.
 Unit 6, Edgefield Industrial Est.
 Loanhead, EH20 9TB
 Tel.: 0131 448 3931

MARCONI MAX 1/ 2
 Balcony door with Weser threshold –
 – T&T version

Version:
 1
 Date:
 15.05.14

Scale:
 1:1
 Drawing:
 NE/18-1

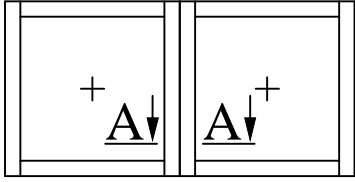

40

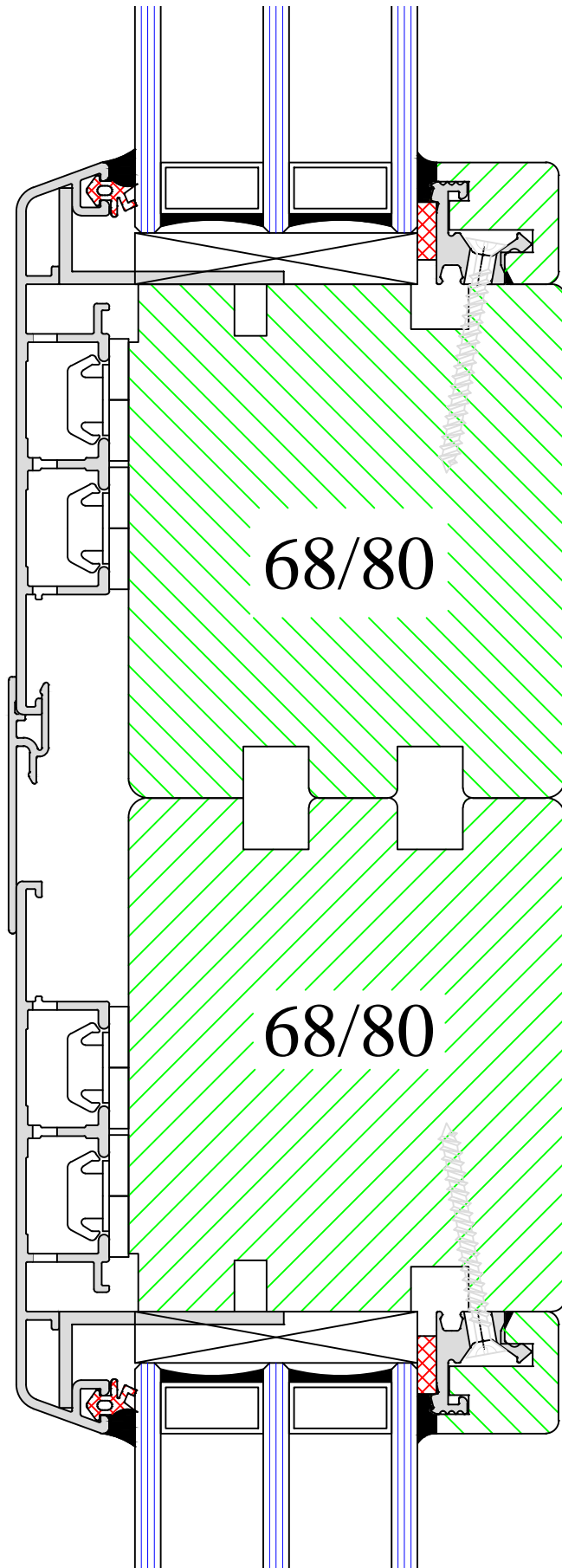

198



UNI WINDOWS Ltd.
 Unit 6, Edgefield Industrial Est.
 Loanhead, EH20 9TB
 Tel.: 0131 448 3931

MARCONI MAX

Two sections connection – vertical

Version:
1

Scale:
1:1

Date:
15.05.14

Drawing:
NE/20

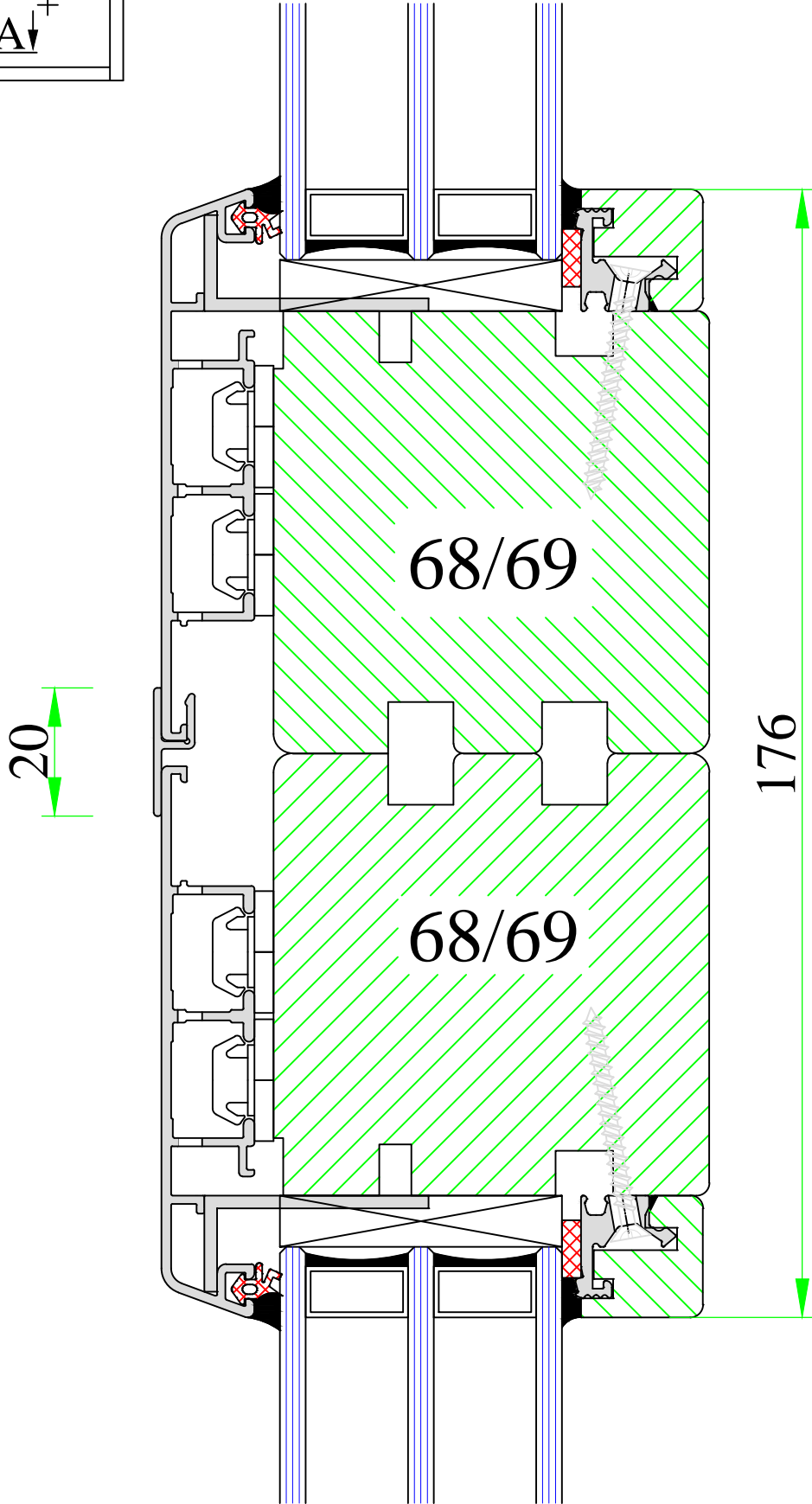
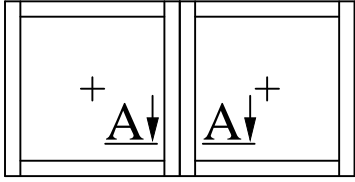

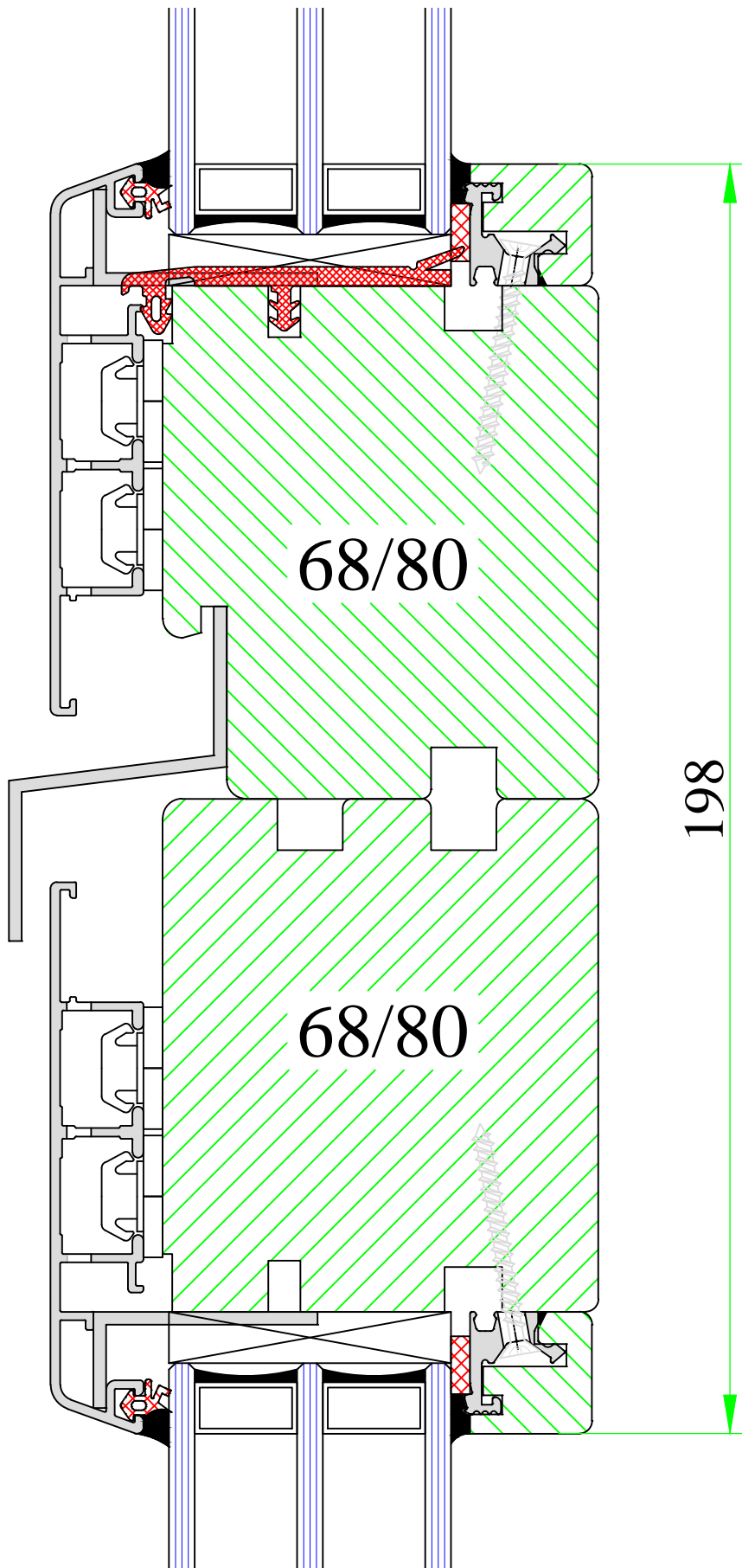
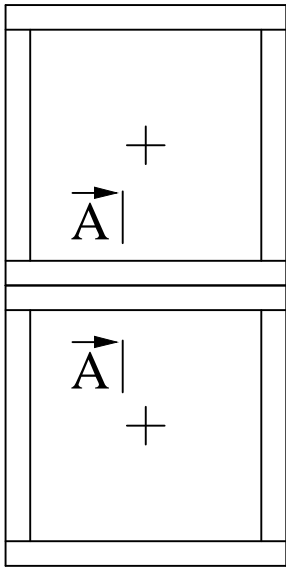

25

198

68/80

68/80



UNI WINDOWS Ltd.
 Unit 6, Edgefield Industrial Est.
 Loanhead, EH20 9TB
 Tel.: 0131 448 3931

MARCONI MAX

Two sections connection – horizontal

Version:
1

Scale:
1:1

Date:
15.05.14

Drawing:
NE/20-1

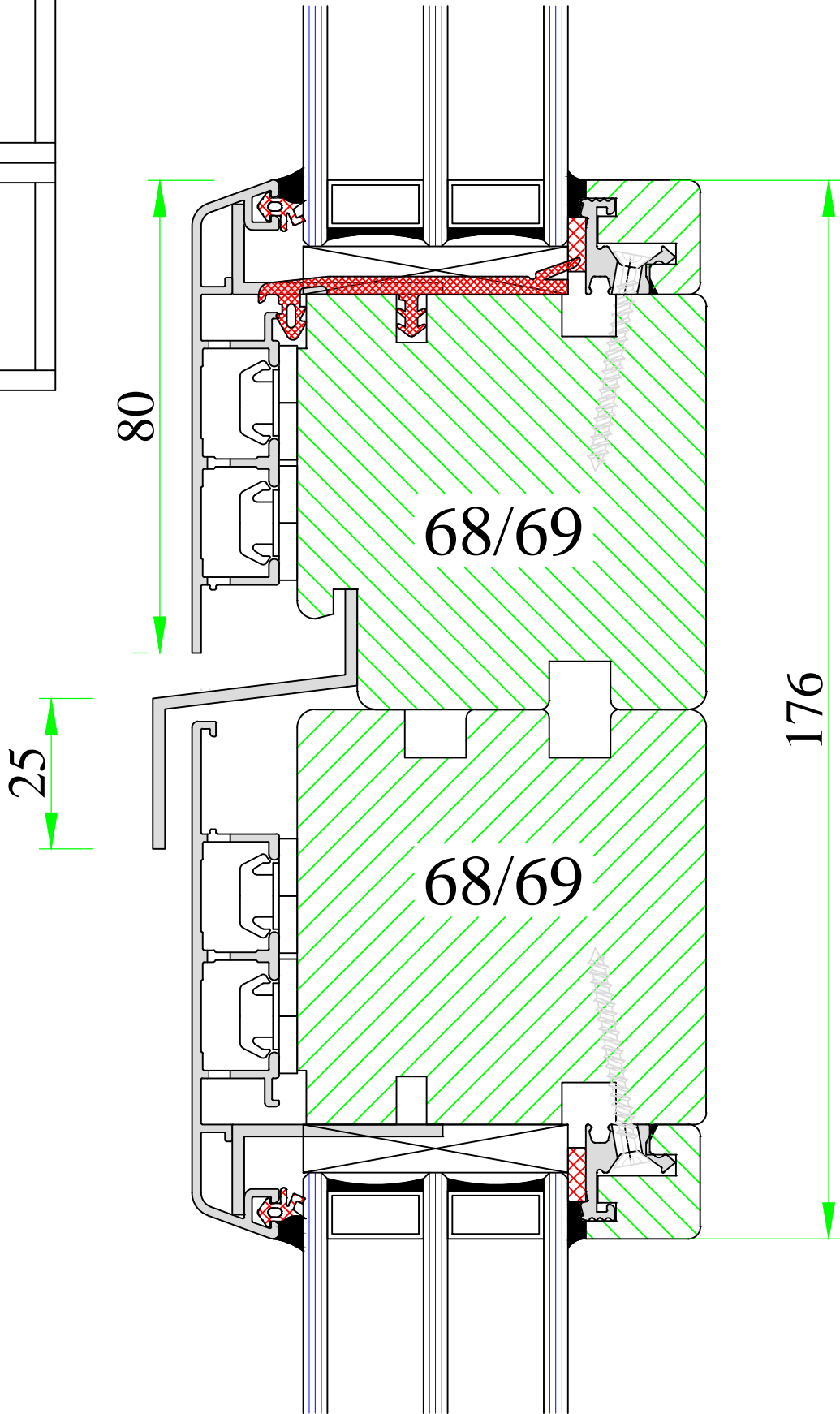
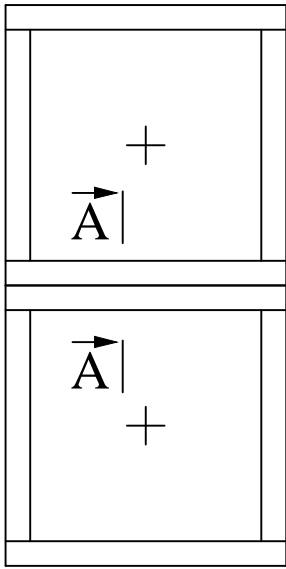

UNI WINDOWS Ltd.
 Unit 6, Edgefield Industrial Est.
 Loanhead, EH20 9TB
 Tel.: 0131 448 3931

MARCONI MAX

Two sections connection – horizontal

Version:
1

Scale:
1:1

Date:
15.05.14

Drawing:
NE2/20-1

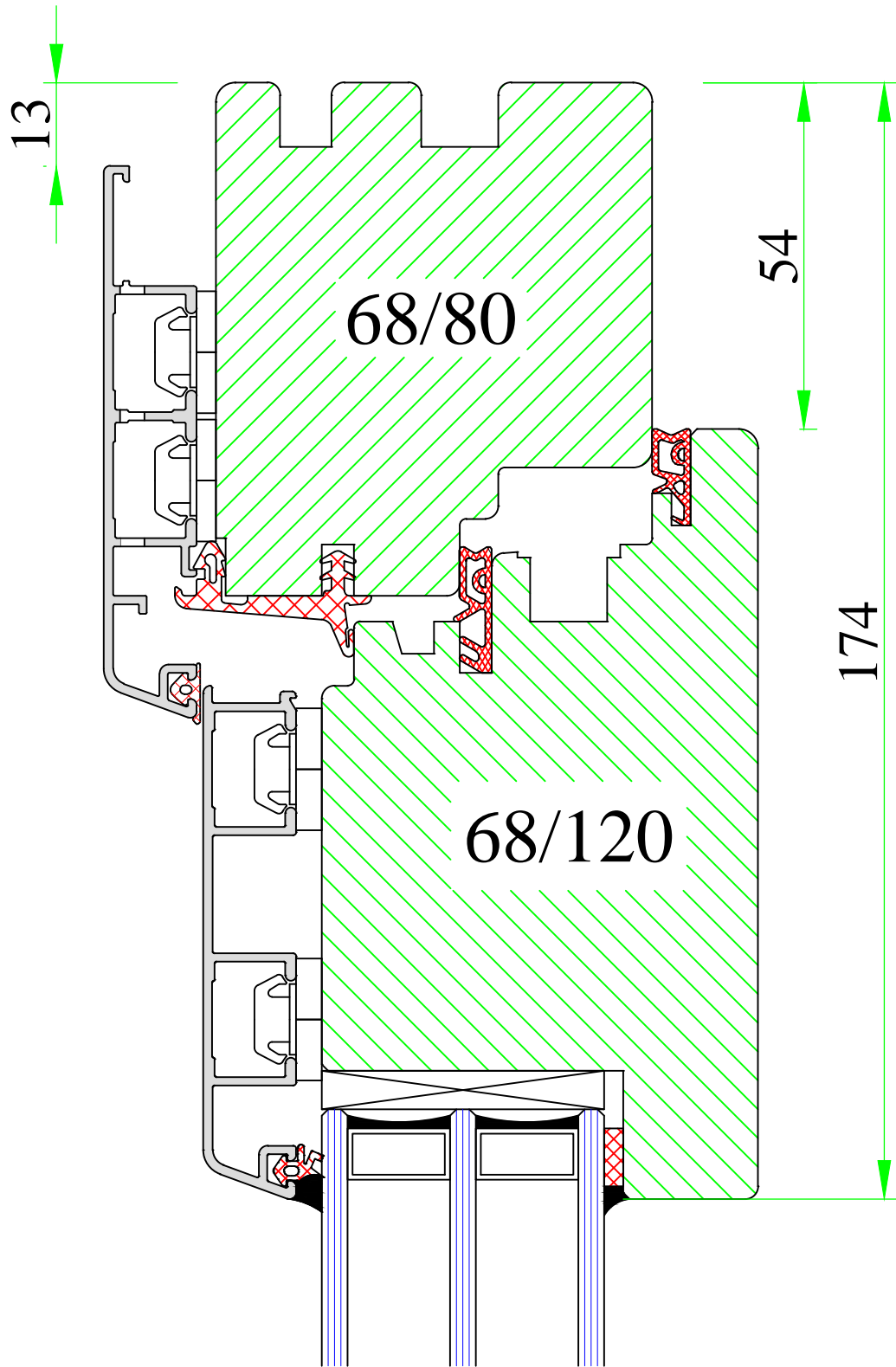
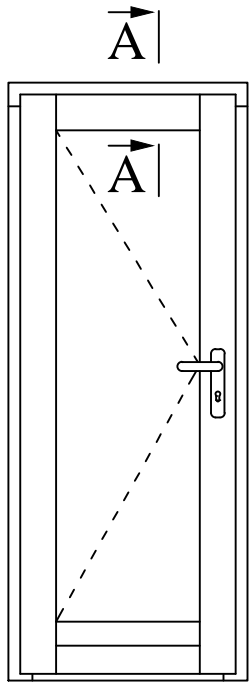

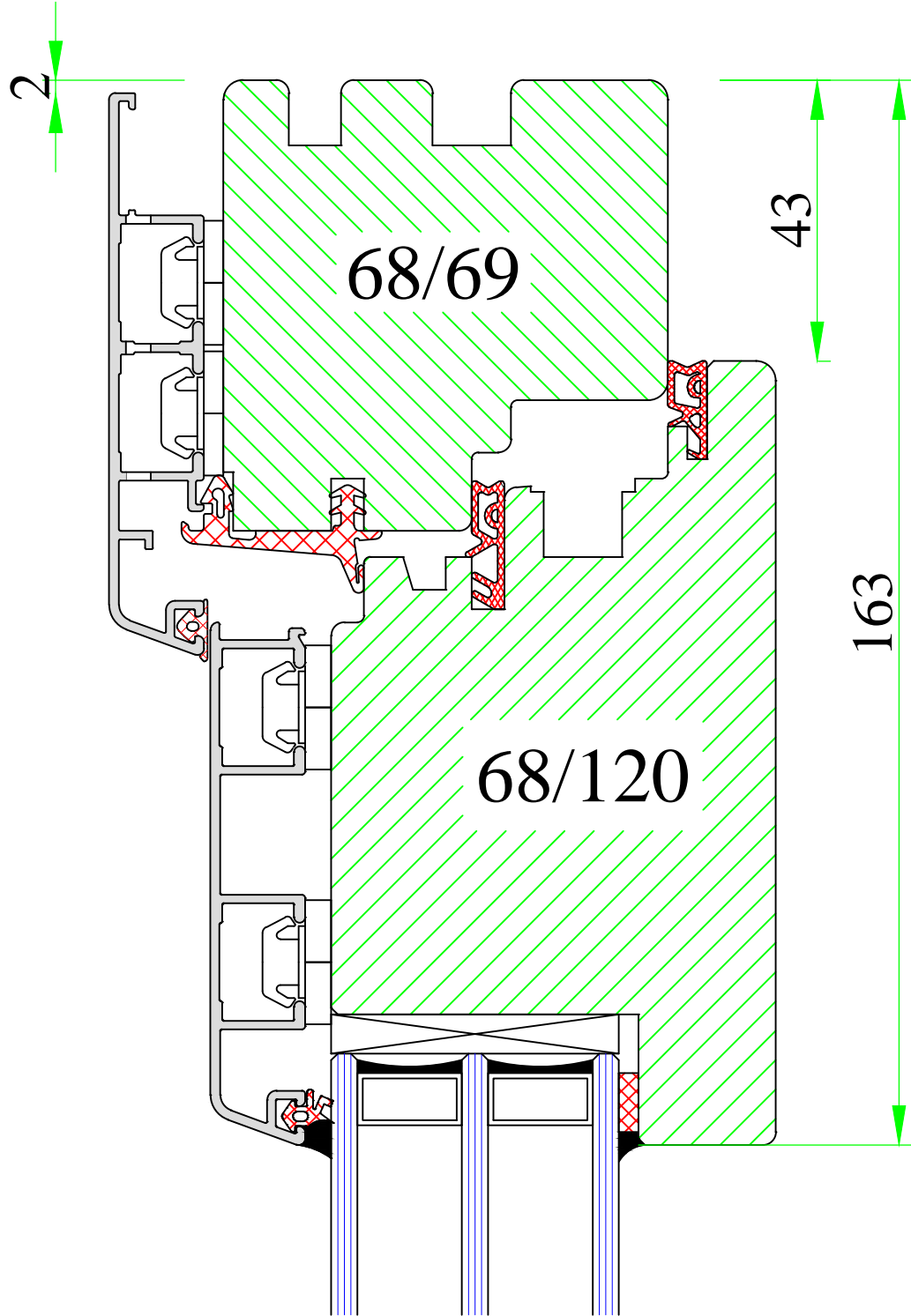
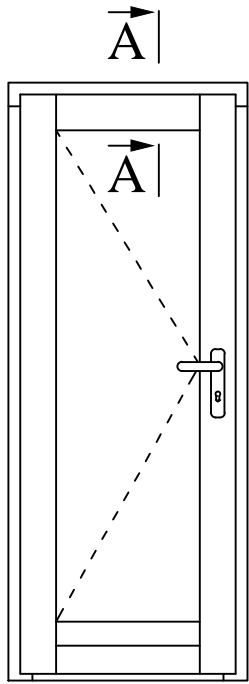

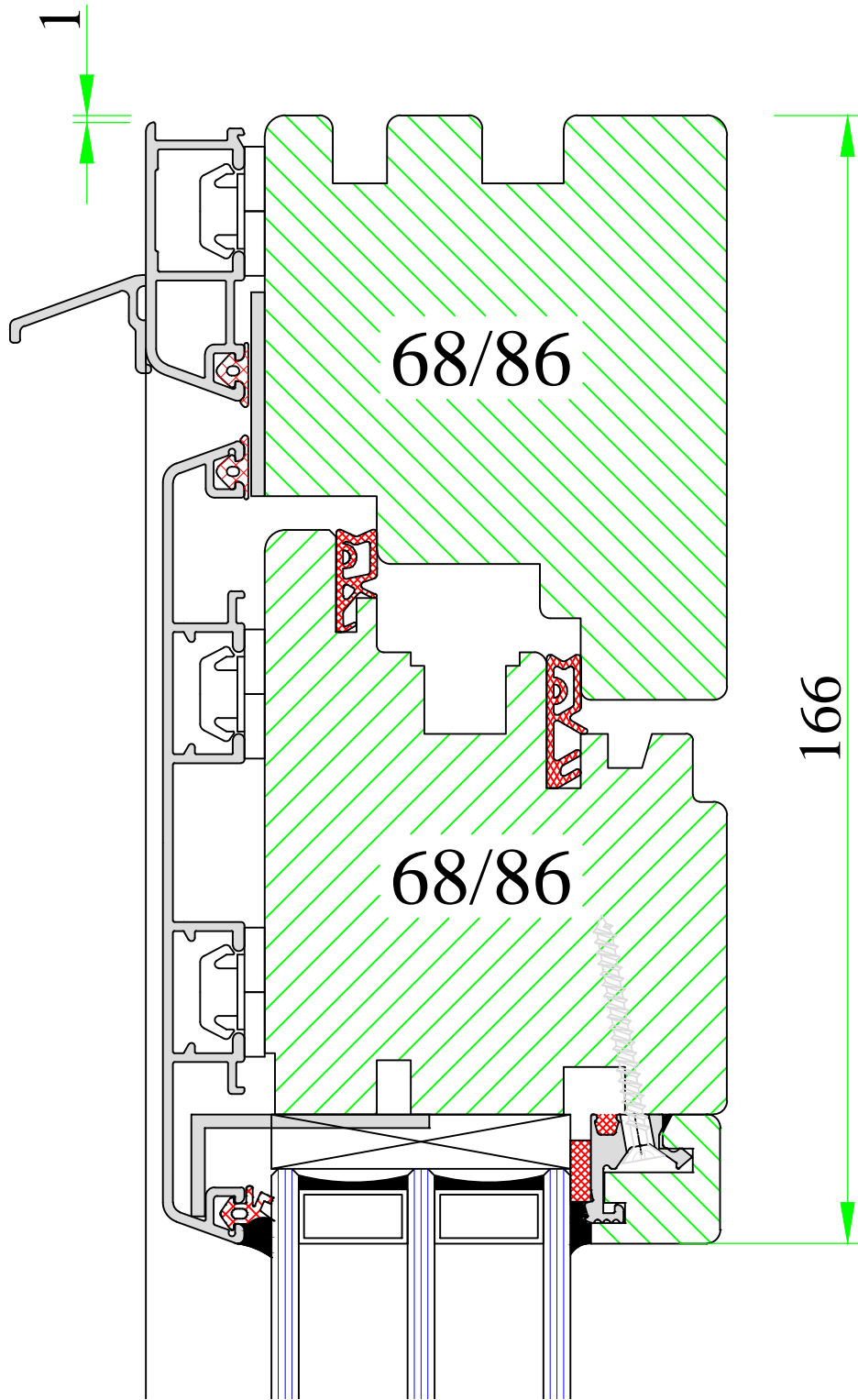
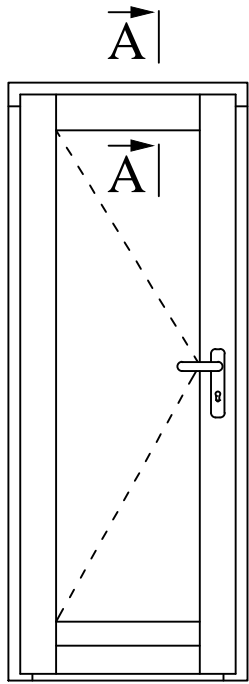

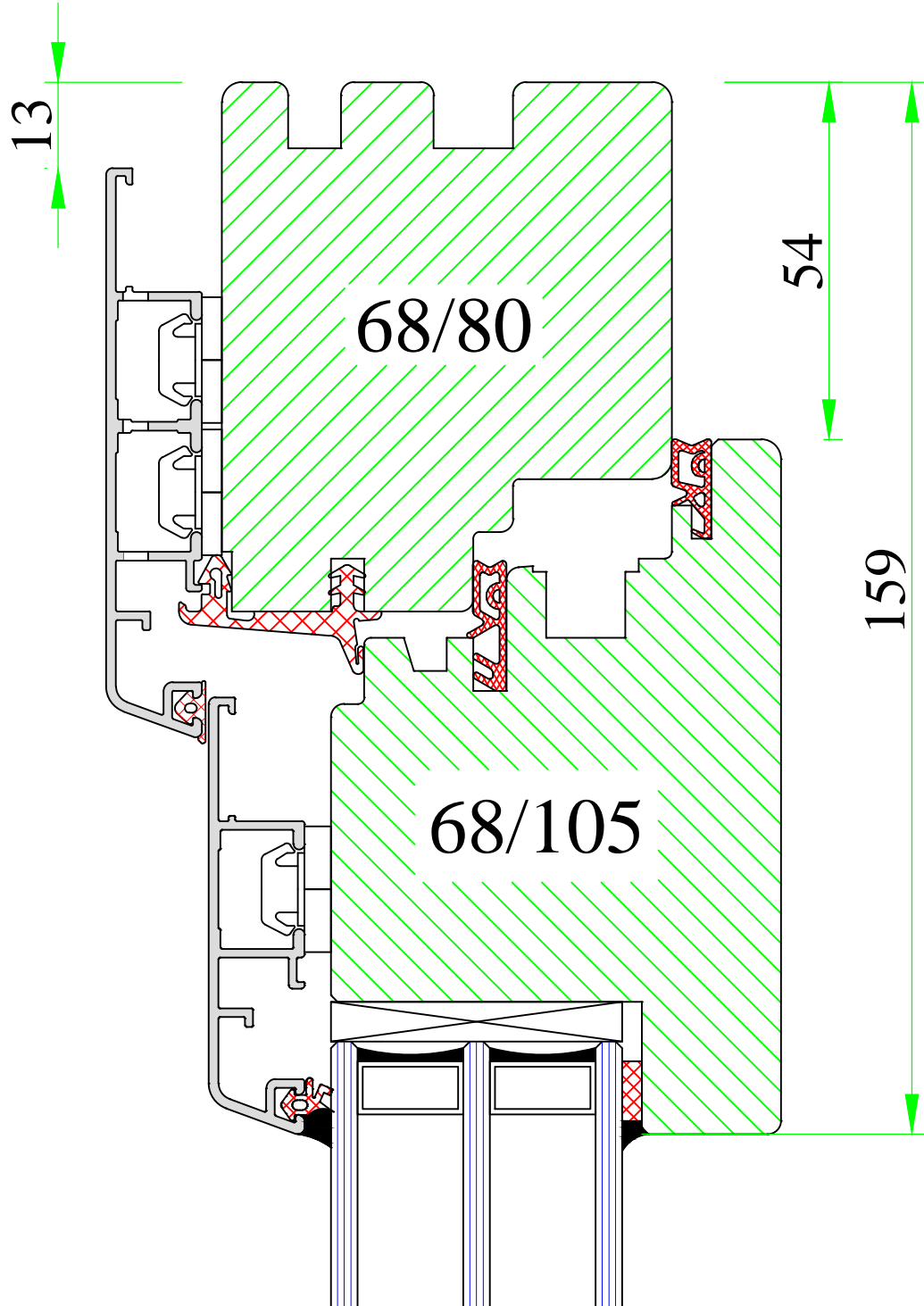
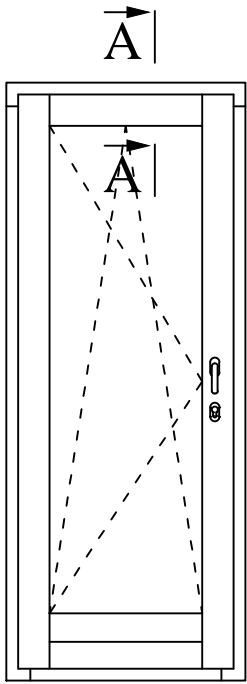

www.uniwin.co.uk



UNI WINDOWS Ltd.
 Unit 6, Edgefield Industrial Est.
 Loanhead, EH20 9TB
 Tel.: 0131 448 3931

MARCONI MAX

Frame-sash door connection – top & sides

Version:
1

Date:
15.05.14

Scale:
1:1

Drawing:
NE/23

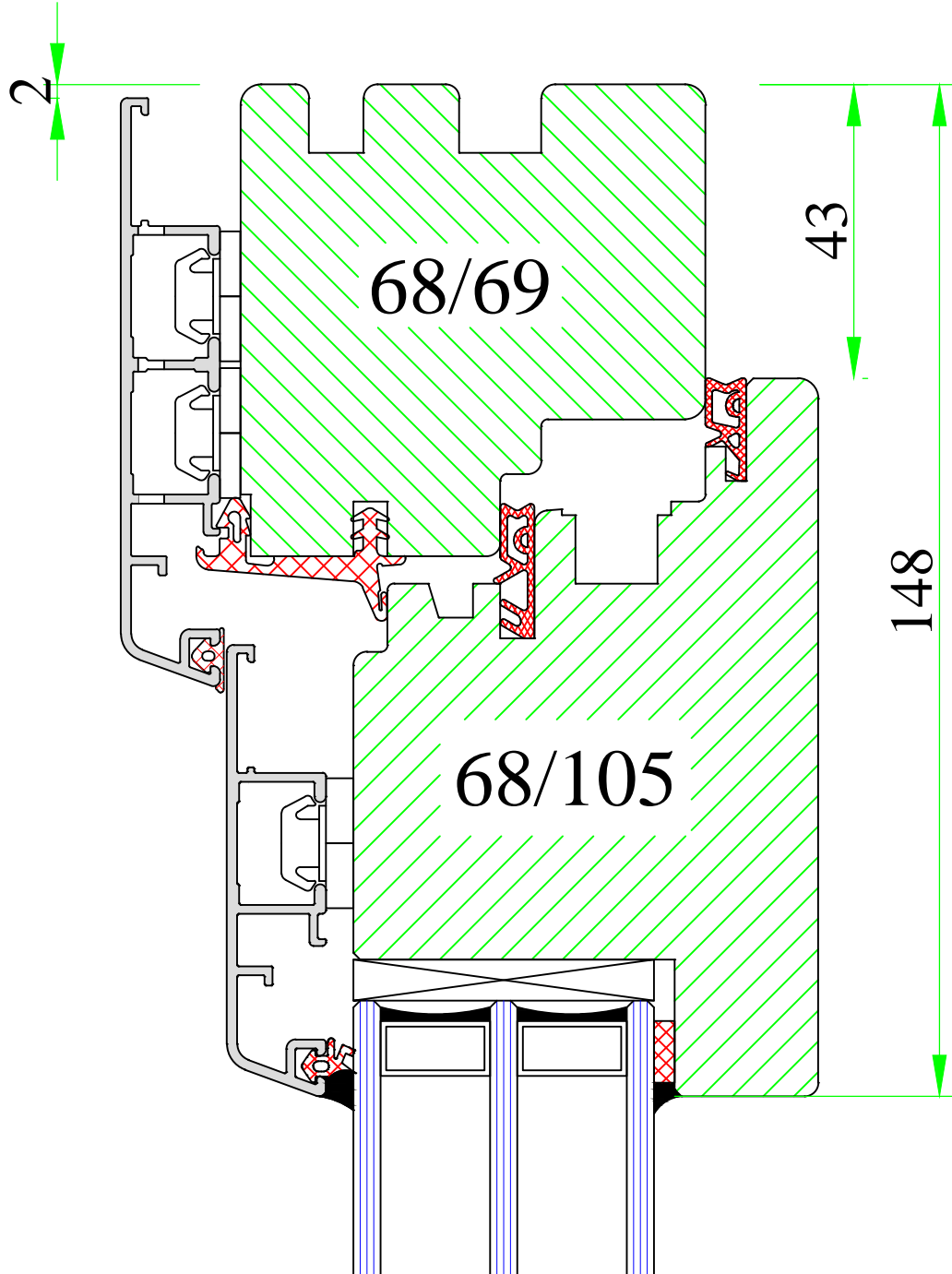
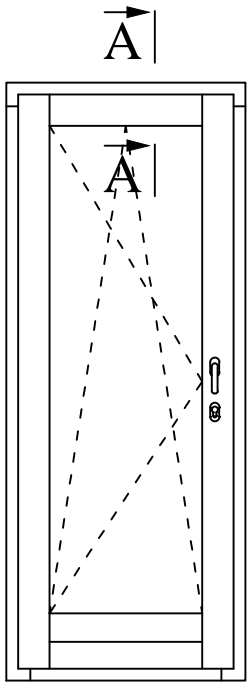

www.uniwin.co.uk



UNI WINDOWS Ltd.
 Unit 6, Edgefield Industrial Est.
 Loanhead, EH20 9TB
 Tel.: 0131 448 3931

MARCONI MAX 2
 Frame-sash door connection – top & sides

Version: 1	Scale: 1:1
Date: 15.05.14	Drawing: NE2/23

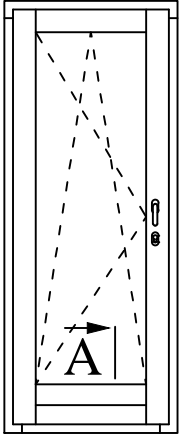

A

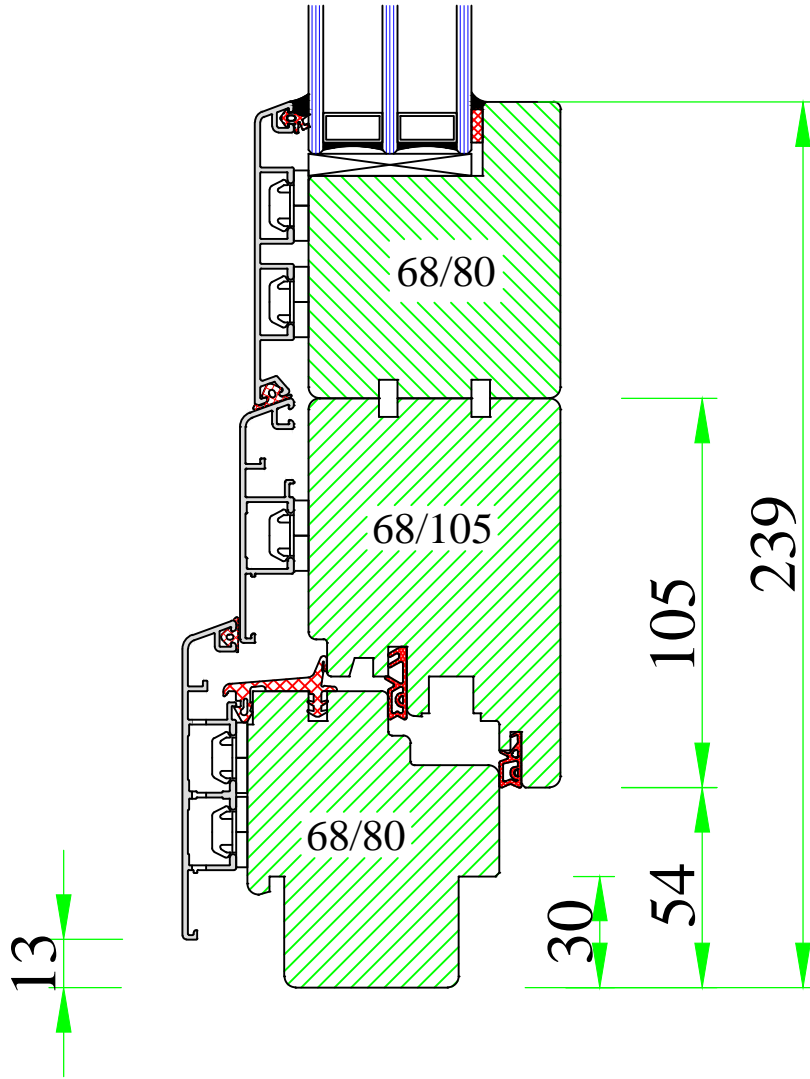

UNI WINDOWS Ltd.
 Unit 6, Edgefield Industrial Est.
 Loanhead, EH20 9TB
 Tel.: 0131 448 3931

MARCONI MAX
 Frame-sash door connection – bottom of
 balcony door

Version:
1
 Date:
15.05.14

Scale:
1:2
 Drawing:
NE/24

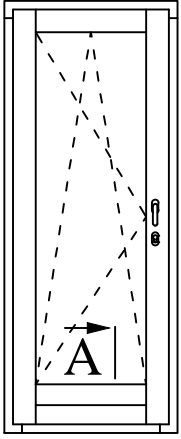

A

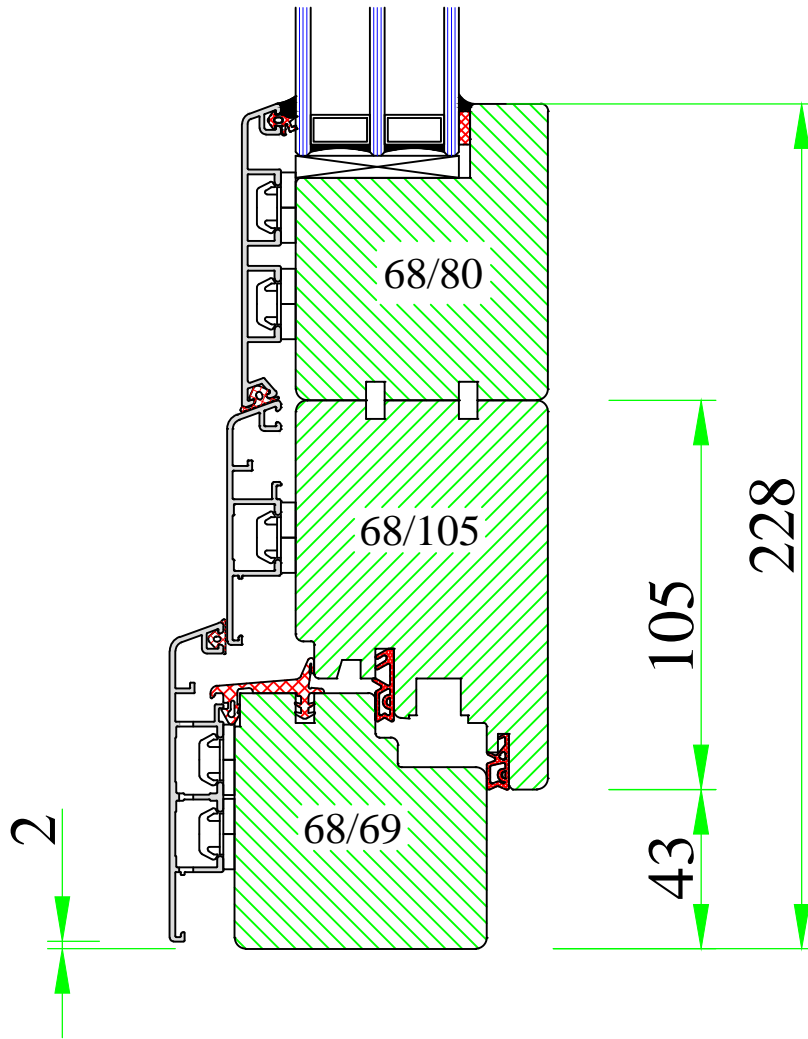

UNI WINDOWS Ltd.
 Unit 6, Edgefield Industrial Est.
 Loanhead, EH20 9TB
 Tel.: 0131 448 3931

MARCONI MAX 2
 Frame-sash door connection – bottom of
 balcony door

Version: 1	Scale: 1:2
Date: 15.05.14	Drawing: NE2/24

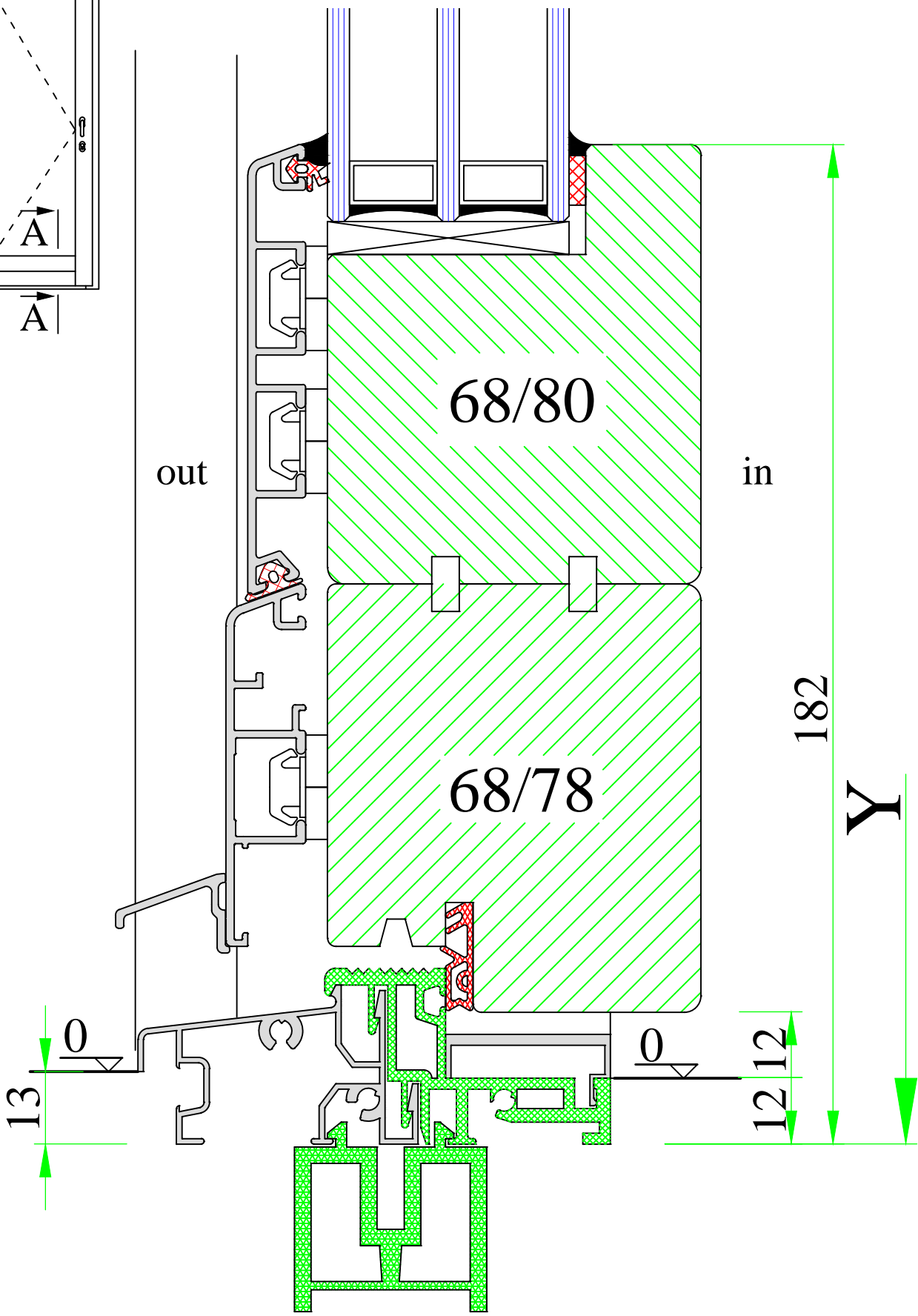
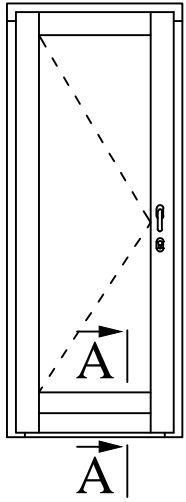

www.uniwin.co.uk



UNI WINDOWS Ltd.
 Unit 6, Edgefield Industrial Est.
 Loanhead, EH20 9TB
 Tel.: 0131 448 3931

MARCONI MAX 1 / 2
 Balcony door with Wesser flat threshold (new)

Version: 1	Scale: 1:1
Date: 15.05.14	Drawing: NE/25

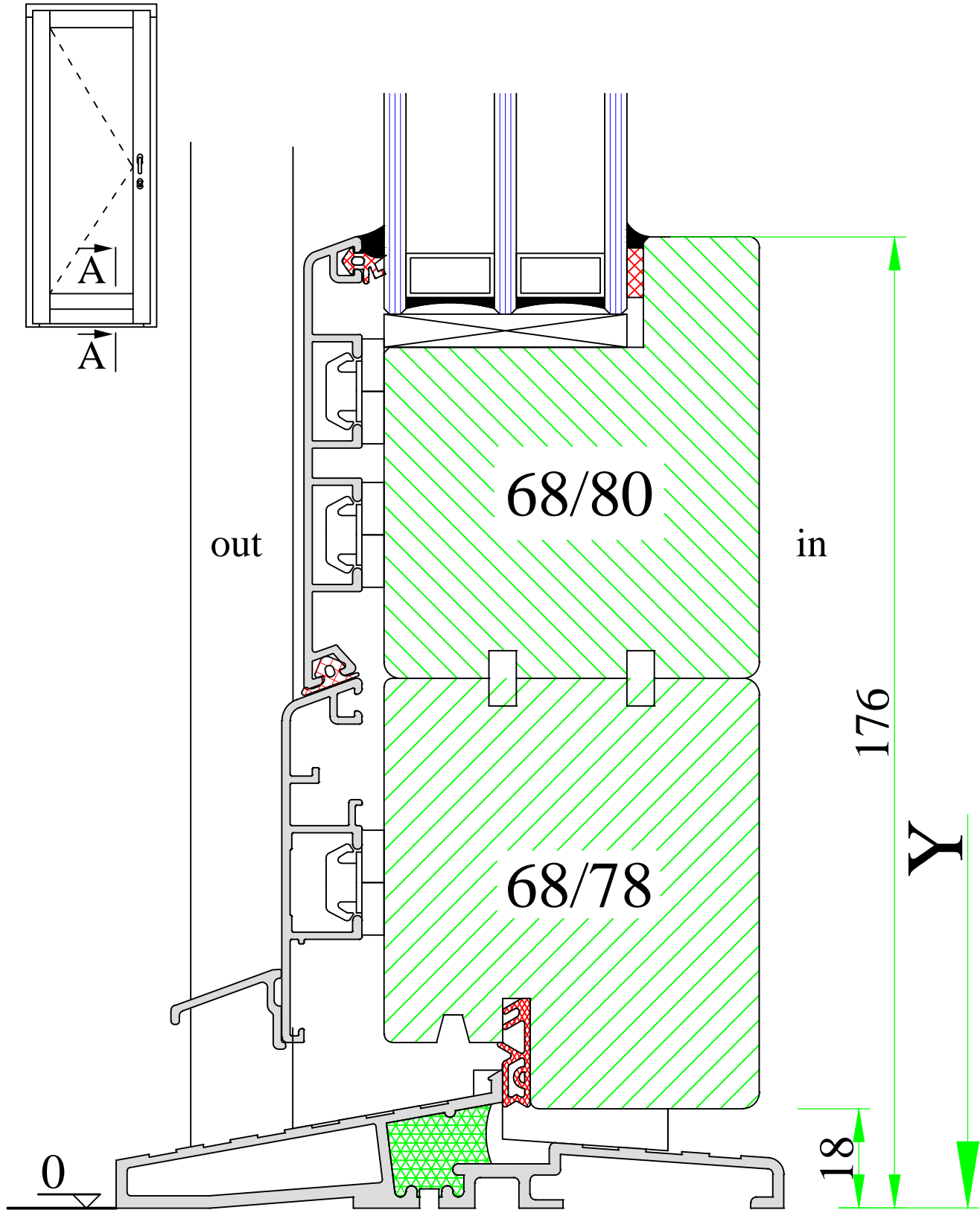

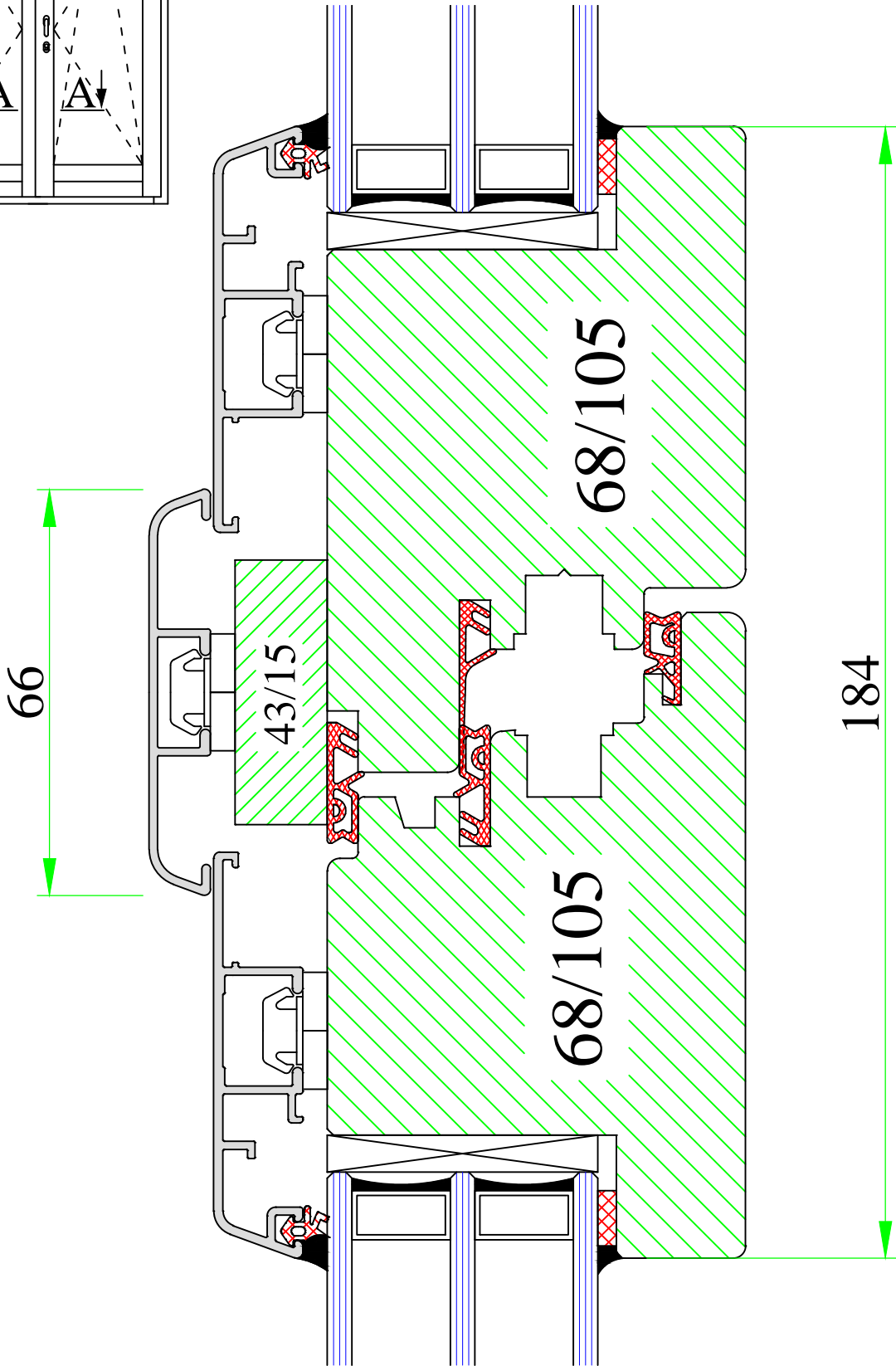
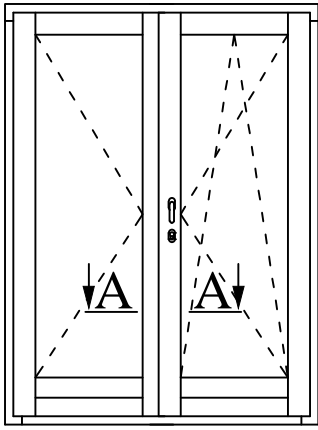

UNI WINDOWS Ltd.
 Unit 6, Edgefield Industrial Est.
 Loanhead, EH20 9TB
 Tel.: 0131 448 3931

"Flying" mullion

MARCONI MAX 1/ 2

Version: 1	Scale: 1:1
Date: 15.05.14	Drawing: NE/27

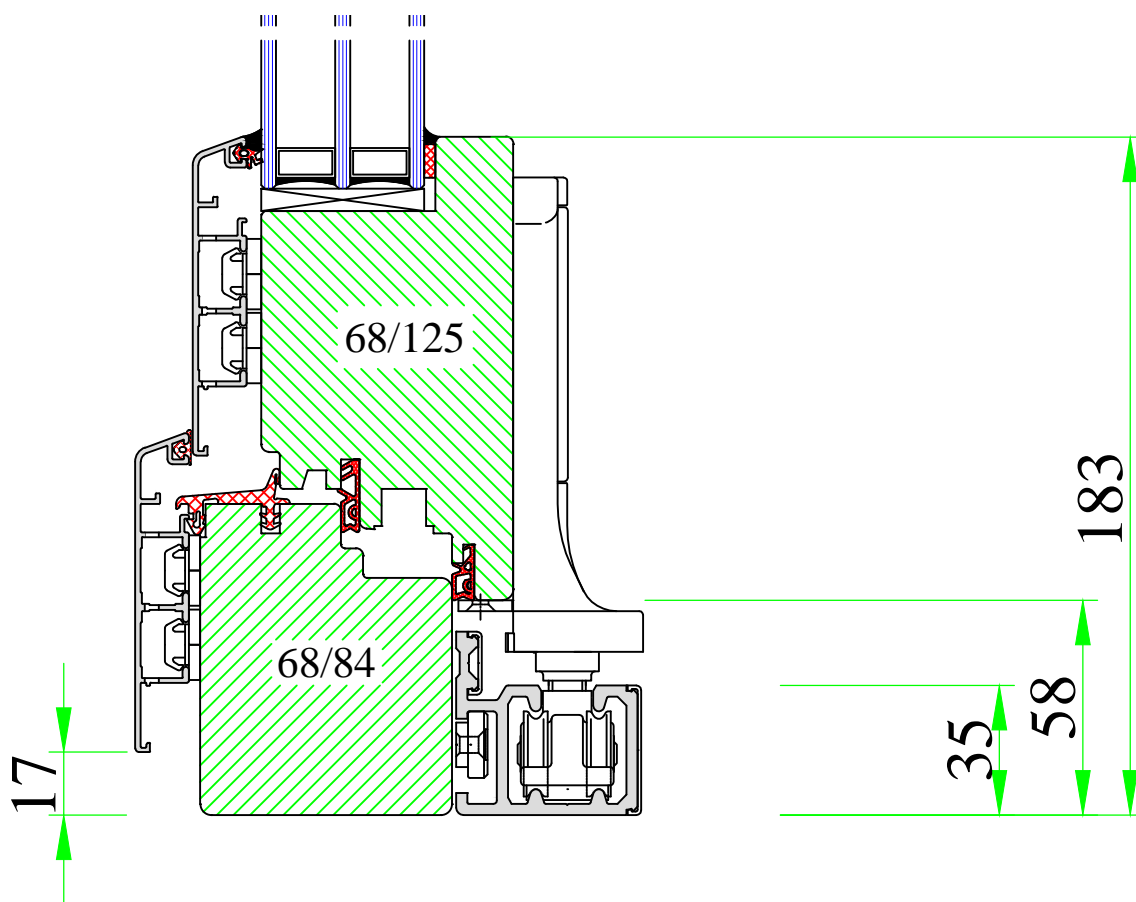
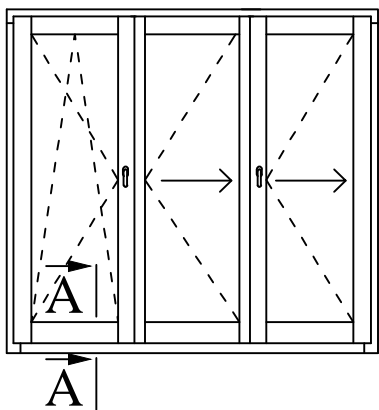

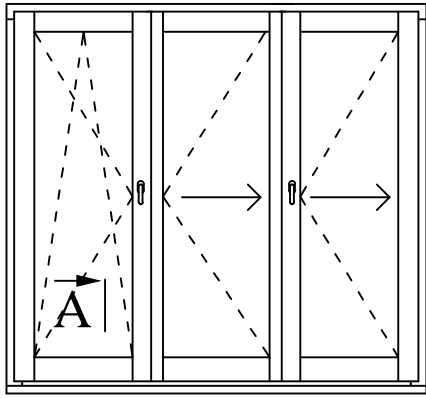

A

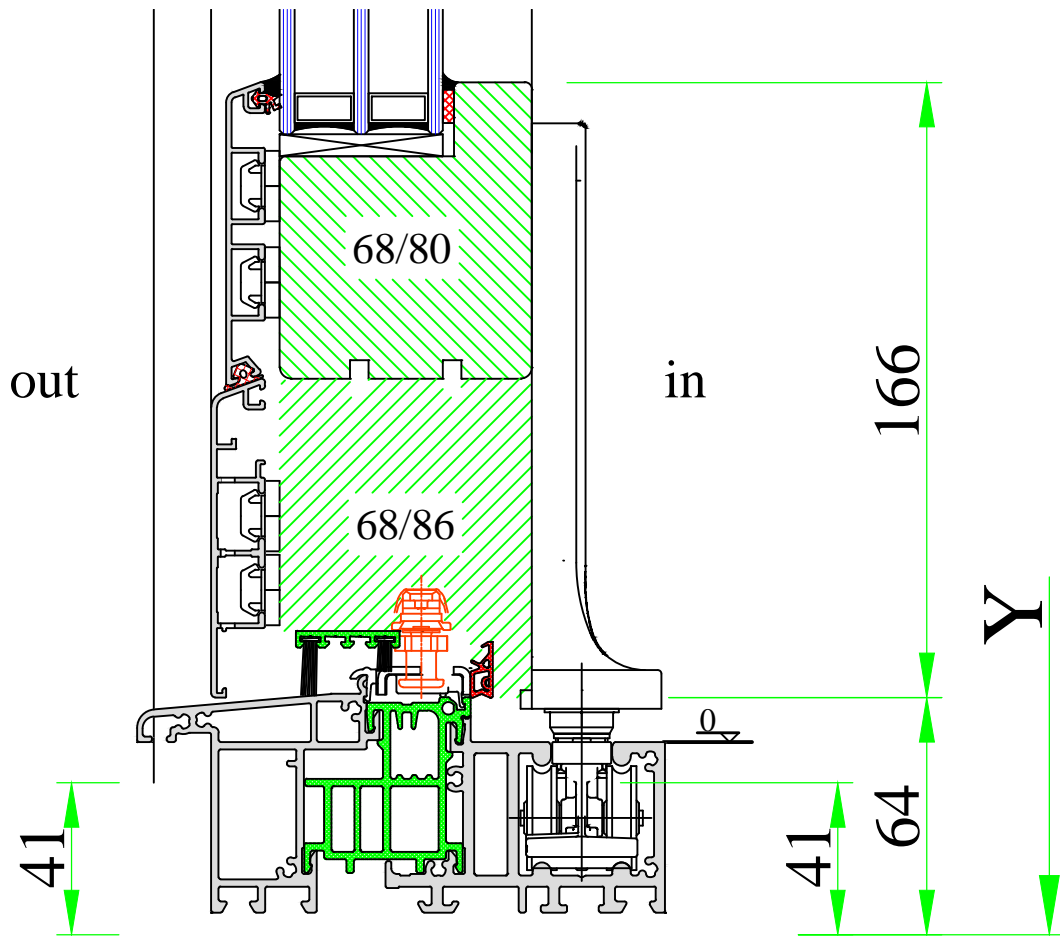

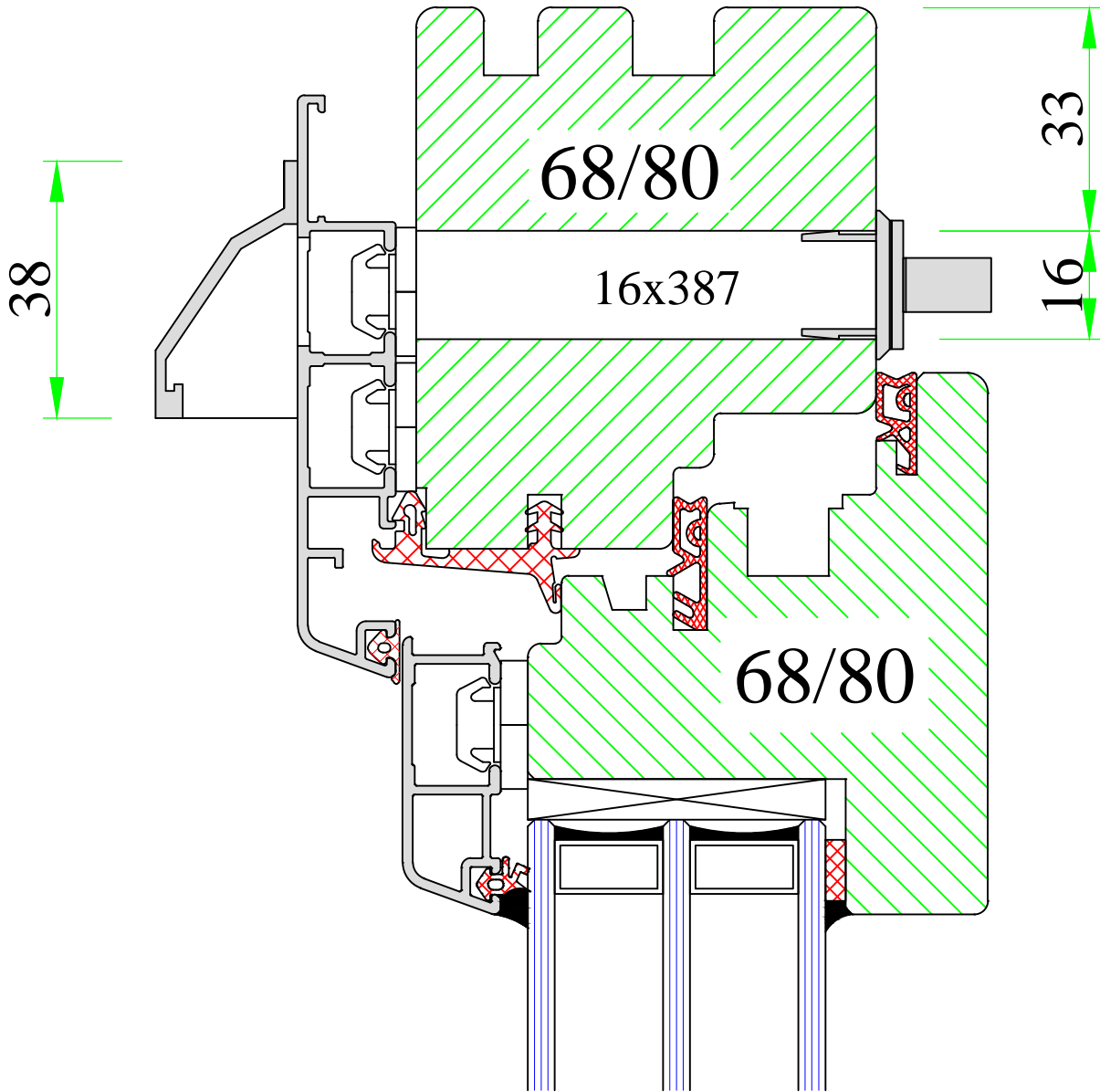
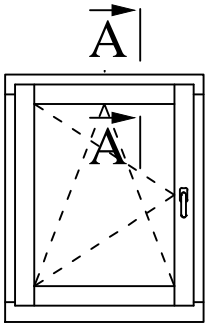

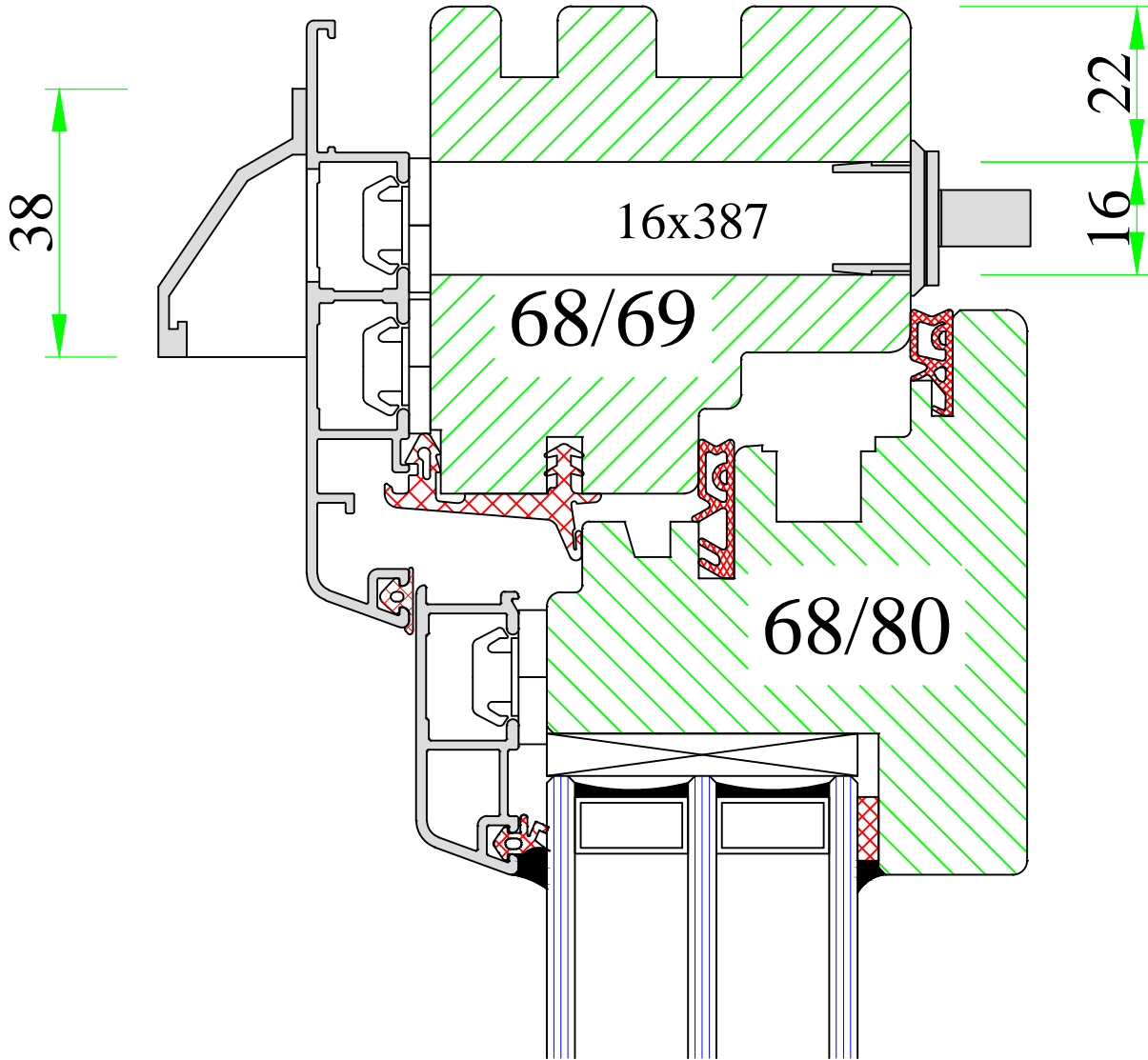
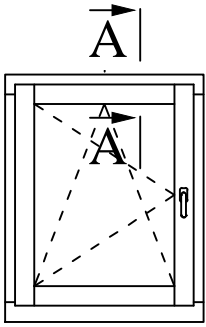

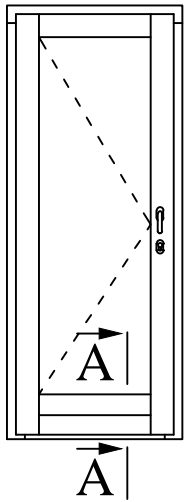

A

0

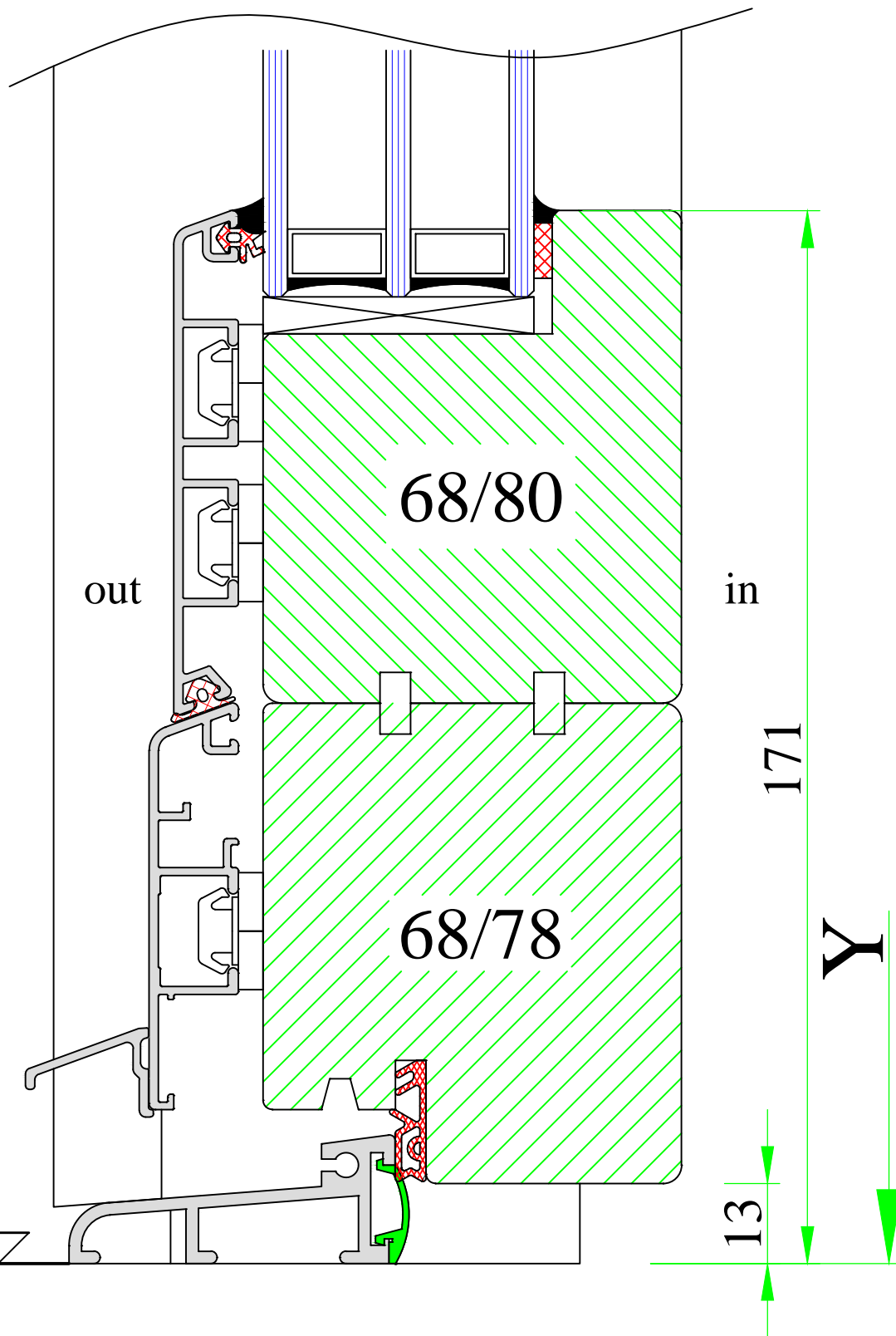

out

68/80

in

68/78

171

Y

13



UNI WINDOWS Ltd.
 Unit 6, Edgefield Industrial Est.
 Loanhead, EH20 9TB
 Tel.: 0131 448 3931

MARCONI MAX 1/ 2
 Balcony door with Wesser threshold (old)

Version:
 1
 Date:
 15.05.14

Scale:
 1:1
 Drawing:
 NE/31